



# Dell™ PowerEdge™ 2800 Systems Installation and Troubleshooting Guide

[Introduction](#)  
[Indicators, Messages, and Codes](#)  
[Finding Software Solutions](#)  
[Running the System Diagnostics](#)  
[Troubleshooting Your System](#)  
[Installing System Components](#)  
[Installing Drives](#)  
[Getting Help](#)  
[Jumpers, Switches, and Connectors](#)  
[I/O Connectors](#)

---

## Notes, Notices, and Cautions

-  **NOTE:** A NOTE indicates important information that helps you make better use of your computer.
-  **NOTICE:** A NOTICE indicates either potential damage to hardware or loss of data and tells you how to avoid the problem.
-  **CAUTION:** A CAUTION indicates a potential for property damage, personal injury, or death.

## Abbreviations and Acronyms

For a complete list of abbreviations and acronyms, see the Glossary in your *User's Guide*.

---

Information in this document is subject to change without notice.  
© 2004 Dell Inc. All rights reserved.

Reproduction in any manner whatsoever without the written permission of Dell Inc. is strictly forbidden.

Trademarks used in this text: *Dell*, the *DELL* logo, *PowerEdge*, *PowerVault*, *Dell OpenManage*, *Dimension*, *Inspiron*, *OptiPlex*, *Latitude*, *Dell Precision*, *PowerApp*, *PowerConnect*, *Axim*, and *DellNet* are trademarks of Dell Inc.

Other trademarks and trade names may be used in this document to refer to either the entities claiming the marks and names or their products. Dell Inc. disclaims any proprietary interest in trademarks and trade names other than its own.

August 2004 P/N P1778 Rev. A00

## Jumpers, Switches, and Connectors

### Dell™ PowerEdge™ 2800 Systems Installation and Troubleshooting Guide

- [Jumpers—A General Explanation](#)
- [System Board Jumpers](#)
- [System Board Connectors](#)
- [Riser Card Connectors](#)
- [SCSI Backplane Connectors](#)
- [Disabling a Forgotten Password](#)

---

This section provides specific information about the system jumpers. It also provides some basic information on jumpers and switches and describes the connectors on the various boards in the system.

---

## Jumpers—A General Explanation

Jumpers provide a convenient and reversible way of reconfiguring the circuitry on a printed circuit board. When reconfiguring the system, you may need to change jumper settings on circuit boards or drives.

### Jumpers

Jumpers are small blocks on a circuit board with two or more pins emerging from them. Plastic plugs containing a wire fit down over the pins. The wire connects the pins and creates a circuit. To change a jumper setting, pull the plug off its pin(s) and carefully fit it down onto the pin(s) indicated. [Figure A-1](#) shows an example of a jumper.

**Figure A-1. Example Jumper**

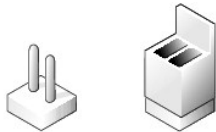

A jumper is referred to as open or unjumped when the plug is pushed down over only one pin or if there is no plug at all. When the plug is pushed down over two pins, the jumper is referred to as jumped. The jumper setting is often shown in text as two numbers, such as 1–2. The number 1 is printed on the circuit board with a triangle so that you can identify each pin number based on the location of pin 1.

[Figure A-2](#) shows the location and default settings of the server-module jumper blocks. See [Table A-1](#) for the designations, default settings, and functions of the jumpers.

---

## System Board Jumpers



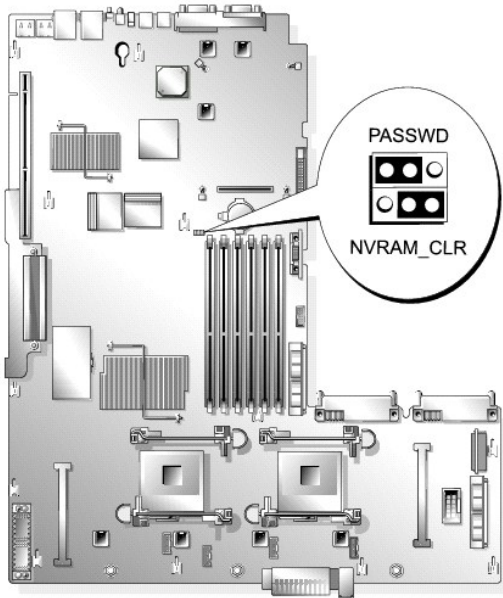

[Figure A-2](#) shows the location of the configuration jumpers on the system board. [Table A-1](#) lists the jumper settings.

 **NOTE:** To access the jumpers, remove the memory cooling shroud by lifting the release latch and sliding the shroud towards the front of the system. See [Figure 6-16](#).

**Figure A-2. System Board Jumpers**



**Table A-1. System Board Jumper Settings**

Jumper	Setting	Description
PASSWD	 (default)	The password feature is enabled.
		The password feature is disabled.
NVRAM_CLR	 (default)	The configuration settings in NVRAM are retained at system boot.
		The configuration settings in NVRAM are cleared at next system boot.

## System Board Connectors

See [Figure A-3](#) and [Table A-2](#) for the location and description of the system board connectors.

**Figure A-3. System Board Connectors**

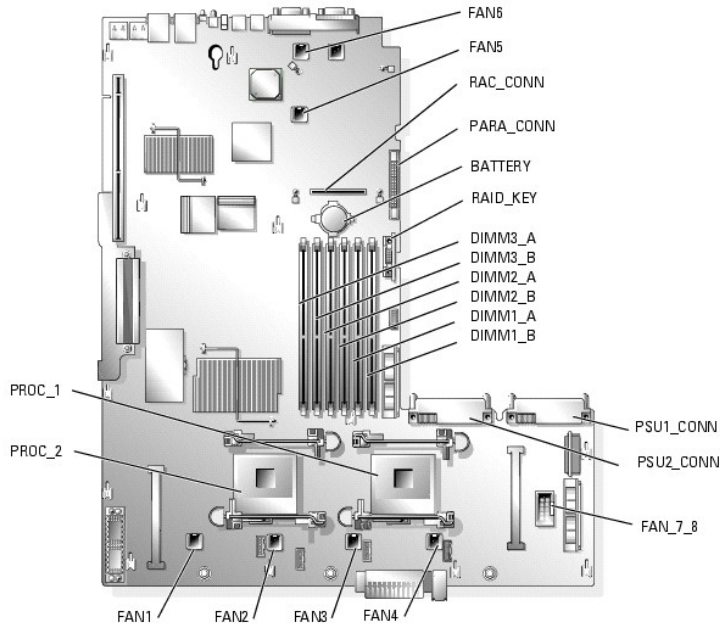

**Table A-2. System Board Connectors**

Connector	Description
BATTERY	Connector for the 3.0-V coin battery
DIMM <sub>n_x</sub>	Memory module connector (6)
FAN <sub>n</sub>	Fan power connector (6)
FAN_7_8	Fan power connector
PARA_CONN	Parallel port connector
PROC_ <sub>n</sub>	Processor connector (2)
PSU <sub>n</sub> _CONN	Power supply connector (2)
RAC_CONN	Connector for the remote access controller (RAC)
RAID_KEY	Connector for the optional RAID key

## Riser Card Connectors

See [Figure A-5](#) for the location of the connectors on the riser card.

**Figure A-4. Riser Card**

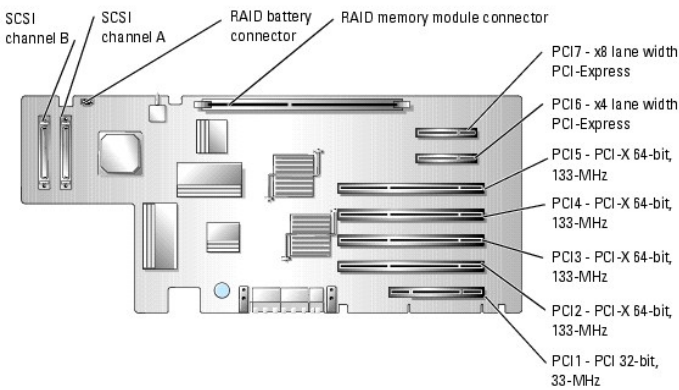

---

## SCSI Backplane Connectors

See [Figure A-5](#) for the location and description of the connectors on the back of the SCSI backplane board.

**Figure A-5. Connectors on Back of SCSI Backplane**

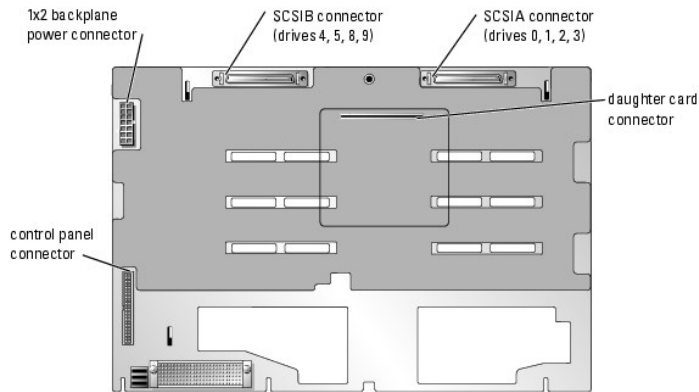

---

## Disabling a Forgotten Password

The system's software security features include a system password and a setup password, which are discussed in detail in "Using the System Setup Program" in your *User's Guide*. The password jumper enables these password features or disables them and clears any password(s) currently in use.

**⚠ CAUTION:** Only trained service technicians are authorized to remove the system cover and access any of the components inside the system. See your *Product Information Guide* for complete information about safety precautions, working inside the computer, and protecting against electrostatic discharge.

1. Turn off the system and attached peripherals, and disconnect the system from the electrical outlet.
2. Open the system. See "[Opening the System](#)" in "Troubleshooting Your System."
3. Remove the memory cooling shroud by lifting the release latch and sliding the shroud towards the front of the system. See [Figure 6-16](#).
4. Remove the password jumper plug.  
See [Figure A-2](#) to locate the password jumper on the system board.
5. Replace the memory cooling shroud.
6. Close the system. See "[Closing the System](#)" in "Troubleshooting Your System."
7. Reconnect the system to the electrical outlet, and turn on the system.

The existing passwords are not disabled (erased) until the system boots with the password jumper plug removed. However, before you assign a new system and/or setup password, you must install the jumper plug.

**🔧 NOTE:** If you assign a new system and/or setup password with the jumper plug still removed, the system disables the new password(s) the next time it boots.

8. Turn off the system, including any attached peripherals, and disconnect the system from the electrical outlet.
9. Open the system.
10. Remove the memory cooling shroud.
11. Reinstall the password jumper plug in its original position to enable the password protection feature.
12. Reinstall the memory cooling shroud.

13. Close the system, reconnect the system to the electrical outlet, and turn on the system.

14. Assign a new system and/or setup password.

To assign a new password using the System Setup program, see "Using the System Setup Program" in your *User's Guide*.

---

[Back to Contents Page](#)

## I/O Connectors

### Dell™ PowerEdge™ 2800 Systems Installation and Troubleshooting Guide

- [Serial Connector](#)
- [Parallel Connector](#)
- [PS/2-Compatible Keyboard and Mouse Connectors](#)
- [Video Connector](#)
- [USB Connectors](#)
- [Integrated NIC Connectors](#)
- [Network Cable Requirements](#)

I/O connectors are the gateways that the system uses to communicate with external devices, such as a keyboard, mouse, printer, or monitor. This section describes the various connectors on your system. If you reconfigure the hardware connected to the system, you may also need the pin number and signal information for these connectors. [Figure B-1](#) illustrates the connectors on the system.

Figure B-1. I/O Connectors

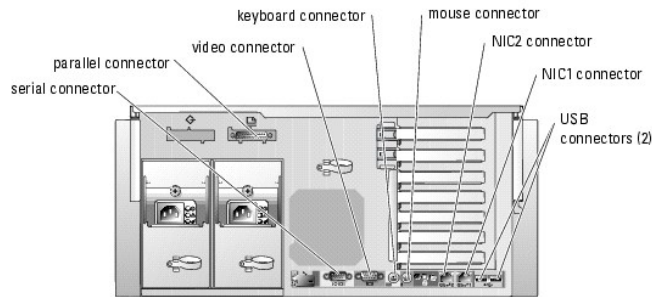

[Table B-1](#) shows the icons used to label the connectors on the system.

Table B-1. I/O Connector Icons

Icon	Connector
	Serial connector
	Parallel connector
	Mouse connector
	Keyboard connector
	Video connector
	USB connector
	NIC connector

---

## Serial Connector

Serial connectors support devices such as external modems, printers, and mice that require serial data transmission. The serial connector is also used by the BMC to provide remote access to the system. The serial connector uses a 9-pin D-subminiature connector.

## Serial Connector Autoconfiguration

The default designation of the integrated serial connector is COM1. When you add an expansion card containing a serial connector that has the same designation as the integrated connector, the system's autoconfiguration feature remaps (reassigns) the integrated serial connector to the next available designation. Both the new and the remapped COM connectors share the same IRQ setting. COM1 and COM3 share IRQ4, while COM2 and COM4 share IRQ3.

**NOTE:** If two COM connectors share an IRQ setting, you may not be able to use them both at the same time. In addition, if you install one or more expansion cards with serial connectors designated as COM1 and COM3, the integrated serial connector is disabled.

Before adding a card that remaps the COM connectors, check the documentation that came with the software to make sure that the software can accommodate the new COM connector designation.

[Figure B-2](#) illustrates the pin numbers for the serial connector and [Table B-2](#) defines the pin assignments for the connector.

**Figure B-2. Serial Connector Pin Numbers**

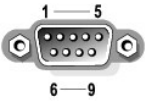

**Table B-2. Serial Connector Pin Assignments**

Pin	Signal	I/O	Definition
1	DCD	I	Data carrier detect
2	SIN	I	Serial input
3	SOUT	O	Serial output
4	DTR	O	Data terminal ready
5	GND	N/A	Signal ground
6	DSR	I	Data set ready
7	RTS	O	Request to send
8	CTS	I	Clear to send
9	RI	I	Ring indicator
Shell	N/A	N/A	Chassis ground

## Parallel Connector

The integrated parallel connector, intended primarily for use by printers that require data in parallel format, uses a 25-pin D-subminiature connector on the system's back panel. The default designation of the system's parallel connector is LPT1. If you add an expansion card containing a parallel connector configured as LPT1 (IRQ7, I/O address 378h), use the System Setup program to remap the integrated parallel connector. See "Using the System Setup Program" in the *User's Guide*. [Figure B-3](#) illustrates the pin numbers for the parallel connector and [Table B-3](#) defines the pin assignments for the connector.

**Figure B-3. Parallel Connector Pin Numbers**

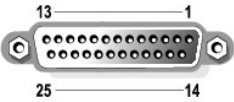

**Table B-3. Parallel Connector Pin Assignments**

Pin	Signal	I/O	Definition
1	STB#	I/O	Strobe
2	PD0	I/O	Printer data bit 0
3	PD1	I/O	Printer data bit 1
4	PD2	I/O	Printer data bit 2
5	PD3	I/O	Printer data bit 3
6	PD4	I/O	Printer data bit 4
7	PD5	I/O	Printer data bit 5
8	PD6	I/O	Printer data bit 6
9	PD7	I/O	Printer data bit 7
10	ACK#	I	Acknowledge
11	BUSY	I	Busy
12	PE	I	Paper end
13	SLCT	I	Select
14	AFD#	O	Automatic feed
15	ERR#	I	Error
16	INIT#	O	Initialize printer
17	SLIN#	O	Select in
18-25	GND	N/A	Ground



---

## PS/2-Compatible Keyboard and Mouse Connectors

The PS/2-compatible keyboard and mouse cables attach to 6-pin, miniature DIN connectors. [Figure B-4](#) illustrates the pin numbers for these connectors and [Table B-4](#) defines the pin assignments for these connectors.

Figure B-4. PS/2-Compatible Keyboard and Mouse Connector Pin Numbers



Table B-4. Keyboard and Mouse Connector Pin Assignments

Pin	Signal	I/O	Definition
1	KBDATA or MDATA	I/O	Keyboard data or mouse data
2	NC	N/A	No connection
3	GND	N/A	Signal ground
4	FVcc	N/A	Fused supply voltage
5	KBCLK or MCLK	I/O	Keyboard clock or mouse clock
6	NC	N/A	No connection
Shell	N/A	N/A	Chassis ground

---

## Video Connector

You can attach a VGA-compatible monitor to the system's integrated video controller using a 15-pin high-density D-subminiature connector on the system front or back panel. [Figure B-5](#) illustrates the pin numbers for the video connector and [Table B-5](#) defines the pin assignments for the connector.

**NOTE:** Installing a video card automatically disables the system's integrated video controller.

Figure B-5. Video Connector Pin Numbers

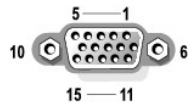

Table B-5. Video Connector Pin Assignments

Pin	Signal	I/O	Definition
1	RED	O	Red video
2	GREEN	O	Green video
3	BLUE	O	Blue video
4	NC	N/A	No connection
5-8, 10	GND	N/A	Signal ground
9	VCC	N/A	Vcc
11	NC	N/A	No connection
12	DDC data out	O	Monitor detect data
13	HSYNC	O	Horizontal synchronization
14	VSUNC	O	Vertical synchronization
15	NC	N/A	No connection

---

## USB Connectors

The system's USB connectors support USB-compliant peripherals such as keyboards, mice, and printers and may also support USB-compliant devices such as diskette drives and optical drives. [Figure B-6](#) illustrates the pin numbers for the USB connector and [Table B-6](#) defines the pin assignments for the connector.

**NOTICE:** Do not attach a USB device or a combination of USB devices that draw a maximum current of more than 500 mA per channel or +5 V. Attaching devices that exceed this threshold may cause the USB connectors to shut down. See the documentation that accompanied the USB devices for their maximum current ratings.

Figure B-6. USB Connector Pin Numbers



Table B-6. USB Connector Pin Assignments

Pin	Signal	I/O	Definition
1	Vcc	N/A	Supply voltage
2	DATA	I	Data in
3	+DATA	O	Data out
4	GND	N/A	Signal ground

## Integrated NIC Connectors

Each of the system's integrated NICs function as a separate network expansion card while providing fast communication between servers and workstations. [Figure B-7](#) illustrates the pin numbers for the NIC connector and [Table B-7](#) defines the pin assignments for the connectors.

Figure B-7. NIC Connector

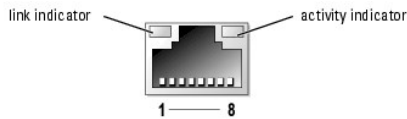

Table B-7. NIC Connector Pin Assignments

Pin	Signal	I/O	Definition
1	TD+	O	Data out (+)
2	TD-	O	Data out (-)
3	RD+	I	Data in (+)
4	NC	N/A	No connection
5	NC	N/A	No connection
6	RD-	I	Data in (-)
7	NC	N/A	No connection
8	NC	N/A	No connection

## Network Cable Requirements

The NIC supports a UTP Ethernet cable equipped with a standard RJ45-compatible plug.

Observe the following cabling restrictions.

**NOTICE:** To avoid line interference, voice and data lines must be in separate sheaths.

- 1 Use Category 5 or greater wiring and connectors.
- 1 Do not exceed a cable run length (from a workstation to a hub) of 100 m (328 ft).

For detailed guidelines on operation of a network, see "Systems Considerations of Multi-Segment Networks" in the IEEE 802.3 standard.

[Back to Contents Page](#)

[Back to Contents Page](#)

## Introduction

### Dell™ PowerEdge™ 2800 Systems Installation and Troubleshooting Guide

#### [Other Documents You May Need](#)

Your system includes the following significant service and upgrade features:

- 1 2x5-character LCD display for error messaging at system startup
- 1 Baseboard Management Controller (BMC), which monitors temperatures and voltages throughout the system and notifies you if the system overheats, if a system cooling fan malfunctions, or if a power supply fails
- 1 Hot-pluggable cooling fans
- 1 System diagnostics, which checks for hardware problems (if the system can boot)

System upgrade options are offered, including:

- 1 An additional microprocessor
- 1 Additional system memory
- 1 An additional hot-pluggable power supply to allow AC redundancy
- 1 A variety of PCI, PCI-X, and PCIe expansion-card options (including RAID controller cards)
- 1 Remote access controller (RAC) for remote systems management
- 1 An integrated RAID controller that can be activated with an additional memory module, key, and battery
- 1 IDE optical drive
- 1 Diskette drive
- 1 Additional hard drives

---

## Other Documents You May Need

 The *Product Information Guide* provides important safety and regulatory information. Warranty information may be included within this document or as a separate document.

- 1 The *Rack Installation Guide* or *Rack Installation Instructions* included with your rack solution describes how to install your system into a rack.
- 1 The *Getting Started Guide* provides an overview of initially setting up your system.
- 1 The *User's Guide* provides information about system features and technical specifications.
- 1 Systems management software documentation describes the features, requirements, installation, and basic operation of the software.
- 1 Operating system documentation describes how to install (if necessary), configure, and use the operating system software.
- 1 Documentation for any components you purchased separately provides information to configure and install these options.
- 1 Updates are sometimes included with the system to describe changes to the system, software, and/or documentation.

 **NOTE:** Always read the updates first because they often supersede information in other documents.

- 1 Release notes or readme files may be included to provide last-minute updates to the system or documentation or advanced technical reference material intended for experienced users or technicians.

---

[Back to Contents Page](#)

[Back to Contents Page](#)

## Indicators, Messages, and Codes

Dell™ PowerEdge™ 2800 Systems Installation and Troubleshooting Guide

- [Front-Panel Indicators and Features](#)
- [Back-Panel Features and Indicators](#)
- [SCSI Hard-Drive Indicator Codes](#)
- [Power Indicator Codes](#)
- [NIC Indicator Codes](#)
- [LCD Status Messages](#)
- [System Messages](#)
- [System Beep Codes](#)
- [Warning Messages](#)
- [Diagnostics Messages](#)
- [Alert Messages](#)
- [Baseboard Management Controller Messages](#)

The system, applications, and operating systems can identify problems and alert you to them. Any of the following can indicate when the system is not operating properly:

- 1 System indicators
- 1 System messages
- 1 Beep codes
- 1 Warning messages
- 1 Diagnostics messages
- 1 Alert messages

This section describes each type of message, lists the possible causes, and provides steps to resolve any problems indicated by a message. The system indicators and features are illustrated in this section.

---

## Front-Panel Indicators and Features

### System Status Indicators

The system front panel incorporates blue and amber system status indicators. The blue indicator lights up when the system is operating correctly. The amber indicator lights up when the system needs attention due to a problem with power supplies, fans, system temperature, or hard drives.

[Table 2-1](#) lists the system's indicator patterns. Different patterns are displayed as events occur in the system.

**Table 2-1. System Status Indicator Patterns**

Blue indicator	Amber indicator	Description
Off	Off	Power is not available to the system.
Off	Blinking	The system has detected an error. See " <a href="#">System Messages</a> " and " <a href="#">Troubleshooting Your System</a> " for more information.
On	Off	Power is on, and the system is operational.
Blinking	Off	The indicator has been activated through system management software or the system identification button to identify the system in a rack.



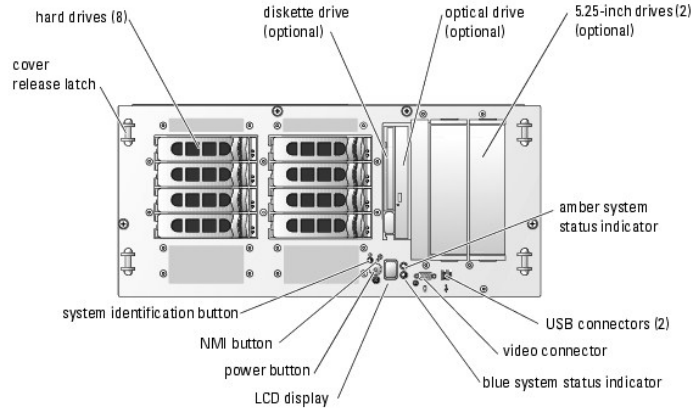

**NOTE:** While the system is being identified, the blue indicator blinks even though an error has been detected. After the system is identified, the blue indicator stops blinking and the amber indicator resumes blinking.

[Figure 2-1](#) shows the controls, indicators, and connectors located behind the optional bezel on the system's front panel. [Table 2-2](#) describes the front-panel features.

**Figure 2-1. Front-Panel Features and Indicators**



**Table 2-2. Front-Panel LED Indicators, Buttons, and Connectors**

Indicator, Button, or Connector	Icon	Description
Blue system status indicator		Does not operate when the bezel is removed. The LCD display indicates the status.
Amber system status indicator		Does not operate when the bezel is removed. The LCD display indicates the status.
LCD display		Provides system ID, status information, and system error messages.  The LCD display lights blue during normal system operation. Both the systems management software and the identification buttons located on the front and back of the system can cause the LCD to flash blue to identify a particular system.  The LCD display lights amber when the system needs attention due to a problem with power supplies, fans, system temperature, or hard drives.  <b>NOTE:</b> If the system is connected to AC power and an error has been detected, the LCD display flashes amber regardless of whether the system has been powered on.
Power-on indicator, power button		The power-on indicator lights when the system power is on. The power-on indicator blinks when power is available to the system, but the system is not powered on.  The power button controls the DC power supply output to the system.  <b>NOTE:</b> If you turn off the system using the power button and the system is running an ACPI-compliant operating system, the system performs a graceful shutdown before the power is turned off. If the system is not running an ACPI-compliant operating system, the power is turned off immediately after the power button is pressed.
System identification button		The identification buttons on the front and back panels can be used to locate a particular system within a rack. When one of these buttons is pushed, the blue system status indicator on the front and back blinks until one of the buttons is pushed again.
USB connectors		Connects USB 2.0-compliant devices to the system.
NMI button		Used to troubleshoot software and device driver errors when using certain operating systems. This button can be pressed using the end of a paper clip.  Use this button only if directed to do so by qualified support personnel or by the operating system's documentation.
Video connector		Connects a monitor to the system.

## Back-Panel Features and Indicators

Figure 2-2 shows the controls, indicators, and connectors located on the system's back panel.

 **NOTE:** Connect the power cable to connector PS1 if your system only has one power supply. See Figure 2-2.

**Figure 2-2. Back-Panel Features and Indicators**

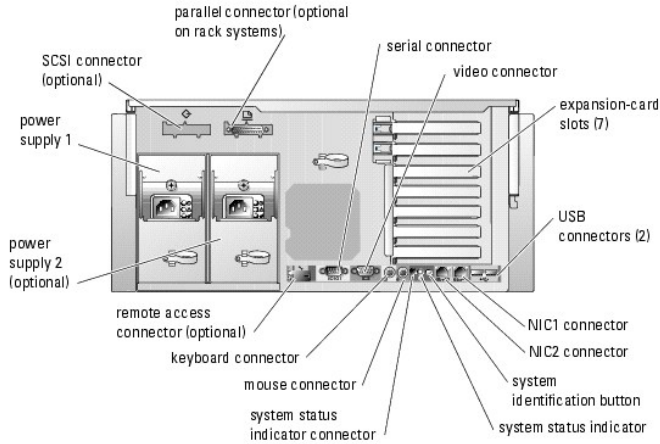

## SCSI Hard-Drive Indicator Codes

If RAID is activated, two indicators on each of the hard-drive carriers provide information on the status of the SCSI hard drives. RAID can be enabled either by activating the system's integrated RAID controller or by using a RAID expansion card connected to the backplane. See [Figure 2-3](#) and [Table 2-3](#). The SCSI backplane firmware controls the drive power-on/fault indicator.

Figure 2-3. SCSI Hard-Drive Indicators

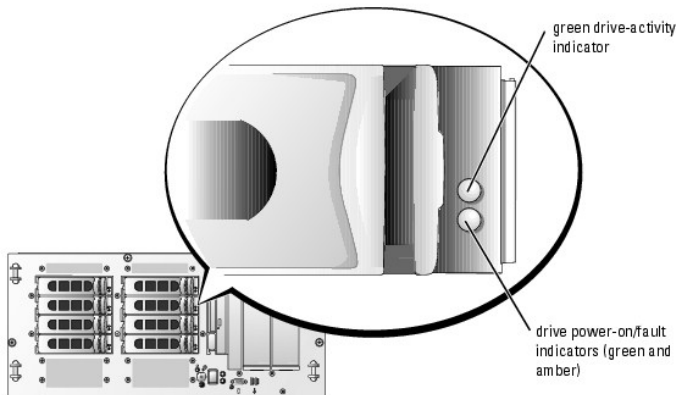

[Table 2-3](#) lists the drive indicator patterns. Different patterns are displayed as drive events occur in the system. For example, if a hard drive fails, the "drive failed" pattern appears. After the drive is selected for removal, the "drive being prepared for removal" pattern appears, followed by the "drive ready for insertion or removal" pattern. After the replacement drive is installed, the "drive being prepared for operation" pattern appears, followed by the "drive online" pattern.

**NOTE:** If a RAID controller is not installed, only the "drive online" indicator pattern appears. The drive-activity indicator also blinks when the drive is being accessed.

Table 2-3. Hard-Drive Indicator Patterns

Condition	Indicator Pattern
Identify drive	The green power-on/fault indicator blinks four times per second.
Drive being prepared for removal	The green power-on/fault indicator blinks two times per second.
Drive ready for insertion or removal	Both drive indicators are off.
Drive being prepared for operation	The green power-on/fault indicator is on.
Drive predicted failure	The power-on/fault indicator slowly blinks green, amber, and off.
Drive failed	The amber power-on/fault indicator blinks four times per second.
Drive rebuilding	The green power-on/fault indicator blinks slowly.
Drive online	The green power-on/fault indicator is on.

## Power Indicator Codes

The power button on the front panel controls the power input to the system's power supplies. The power indicator can provide information on power status (see [Figure 2-1](#)). [Table 2-4](#) lists the power button indicator codes.

**Table 2-4. Power Button Indicators**

Indicator	Function
On	Indicates that power is supplied to the system and the system is operational.
Off	Indicates that no power is supplied to the system.
Blinking	Indicates that power is supplied to the system, but the system is in a standby state. For information on standby states, see your operating system documentation.

The indicators on the optional redundant power supplies show whether power is present or whether a power fault has occurred (see [Figure 2-4](#)).

**Figure 2-4. Redundant Power Supply Indicators**

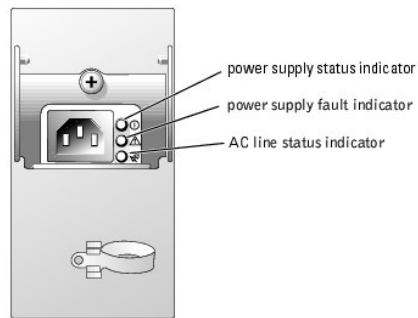
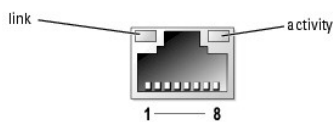

**Table 2-5. Redundant Power Supply Indicators**

Indicator	Function
Power supply status	Green indicates that the power supply is operational.
Power supply fault	Amber indicates a problem with the power supply.
AC line status	Green indicates that a valid AC source is connected to the power supply.

## NIC Indicator Codes

**Figure 2-5. NIC Indicators**



**Table 2-6. NIC Indicators**

Link indicator	Activity indicator	Description
Off	Off	The NIC is not connected to the network or the NIC is disabled in the System Setup screen. See "Using the System Setup Program" in the <i>User's Guide</i> .
Green	Off	Indicates that the network adapter is connected to a valid link partner on the network, but data is not currently being sent or received.
Green	Blinking amber	Indicates that network data is being sent or received.

## LCD Status Messages

The system status indicator can signify when the system is operating correctly or when the system needs attention. When the system status indicator signifies

an error condition, remove the optional bezel to see further information provided by the status LCD.

The LCD can display two lines of alphanumeric characters. The display codes are presented in two color combinations:

- 1 White characters on a blue background — Information only; no action is required.
- 1 Amber characters on a black background — The system needs attention.

[Table 2-7](#) lists the LCD status messages that can occur and the probable cause for each message. The LCD messages refer to events recorded in the system event log (SEL). For information on the SEL and configuring system management settings, see the systems management software documentation.

**⚠ CAUTION:** Only trained service technicians are authorized to remove the system cover and access any of the components inside the system. See your *Product Information Guide* for complete information about safety precautions, working inside the computer, and protecting against electrostatic discharge.

**Table 2-7. LCD Status Messages**

Line 1 Message	Line 2 Message	Causes	Corrective Actions
<i>SYSTEM ID</i>	<i>SYSTEM NAME</i>	<p><i>SYSTEM ID</i> is a unique name, five characters or less, defined by the user.</p> <p><i>SYSTEM NAME</i> is a unique name, 16 characters or less, defined by the user.</p> <p>The system ID and name display under the following conditions:</p> <ul style="list-style-type: none"> <li>1 The system is powered on.</li> <li>1 The power is off and active POST errors are displayed.</li> </ul>	<p>This message is for information only.</p> <p>You can change the system ID and name in the System Setup program. See your system's <i>User's Guide</i> for instructions.</p>
E0000	OVRFLW CHECK LOG	<p>LCD overflow message.</p> <p>A maximum of three error messages can display sequentially on the LCD. The fourth message displays as the standard overflow message.</p>	Check the SEL for details on the events.
E0119	TEMP AMBIENT	Ambient system temperature is out of acceptable range.	See " <a href="#">Troubleshooting System Cooling Problems</a> " in "Troubleshooting Your System."
E0119	TEMP BP	Backplane board is out of acceptable temperature range.	
E0119	TEMP CPU <i>n</i>	Specified microprocessor is out of acceptable temperature range.	See " <a href="#">Troubleshooting System Cooling Problems</a> " in "Troubleshooting Your System." If the problem persists, ensure that the microprocessor heat sinks are properly installed (see " <a href="#">Replacing a Processor</a> " in "Installing System Components").
E0119	TEMP SYSTEM	System board is out of acceptable temperature range.	See " <a href="#">Troubleshooting System Cooling Problems</a> " in "Troubleshooting Your System."
E0212	VOLT 3.3	System power supply is out of acceptable voltage range; faulty or improperly installed power supply.	See " <a href="#">Troubleshooting Redundant Power Supplies</a> " in "Troubleshooting Your System."
E0212	VOLT 5		
E0212	VOLT 12		
E0212	VOLT BATT	Faulty battery; faulty system board.	See " <a href="#">Troubleshooting the System Battery</a> " in "Troubleshooting Your System."
E0212	VOLT BP 12	Backplane board is out of acceptable voltage range.	See " <a href="#">Troubleshooting Redundant Power Supplies</a> " in "Troubleshooting Your System."
E0212	VOLT BP 3.3		
E0212	VOLT BP 5		
E0212	VOLT CPU VRM	Microprocessor VRM voltage is out of acceptable range; faulty or improperly installed microprocessor VRM; faulty system board.	This message is not applicable to this system.
E0212	VOLT NIC 1.8V	Integrated NIC voltage is out of acceptable range; faulty or improperly installed power supply; faulty system board.	See " <a href="#">Troubleshooting Redundant Power Supplies</a> " in "Troubleshooting Your System."
E0212	VOLT NIC 2.5V		
E0212	VOLT PLANAR REG	System board is out of acceptable voltage range; faulty or improperly installed system board.	
E0276	CPU VRM <i>n</i>	Specified microprocessor VRM is faulty, unsupported, improperly installed, or missing.	These messages are not applicable to this system.
E0276	MISMATCH VRM <i>n</i>		
E0280	MISSING VRM <i>n</i>		
E0319	PCI OVER CURRENT	Faulty or improperly installed expansion card.	See " <a href="#">Troubleshooting Expansion Cards</a> " in "Troubleshooting Your System."
E0412	RPM FAN <i>n</i>	Specified cooling fan is faulty, improperly installed, or missing.	See " <a href="#">Troubleshooting System Cooling Problems</a> " in "Troubleshooting Your System."
E0780	MISSING CPU 1	Microprocessor is not installed in socket 1.	Install a microprocessor in socket 1 (see " <a href="#">Replacing a Processor</a> " in "Installing System Components"). To identify microprocessor socket 1, see <a href="#">Figure A-3</a> .
E07F0	CPU IERR	Faulty or improperly installed microprocessor.	See " <a href="#">Troubleshooting the Microprocessors</a> " in "Troubleshooting Your System."



E07F1	TEMP CPU <i>n</i> HOT	Specified microprocessor is out of acceptable temperature range and has halted operation.	See " <a href="#">Troubleshooting System Cooling Problems</a> " in "Troubleshooting Your System." If the problem persists, ensure that the microprocessor heat sinks are properly installed (see " <a href="#">Replacing a Processor</a> " in "Installing System Components").
E07F4	POST CACHE	Faulty or improperly installed microprocessor.	See " <a href="#">Troubleshooting the Microprocessors</a> " in "Troubleshooting Your System."
E07F4	POST CPU REG		
E07F4	POST CPU SMI		
E07FA	TEMP CPU <i>n</i> THERM	Specified microprocessor is out of acceptable temperature range and is operating at a reduced speed, or frequency.	See " <a href="#">Troubleshooting System Cooling Problems</a> " in "Troubleshooting Your System." If the problem persists, ensure that the microprocessor heat sinks are properly installed (see " <a href="#">Replacing a Processor</a> " in "Installing System Components").
E0876	POWER PS <i>n</i>	No power available from the specified power supply; specified power supply is improperly installed or faulty.	See " <a href="#">Troubleshooting Redundant Power Supplies</a> " in "Troubleshooting Your System."
E0880	INSUFFICIENT PS	Insufficient power is being supplied to the system; power supplies are improperly installed, faulty, or missing.	See " <a href="#">Troubleshooting Redundant Power Supplies</a> " in "Troubleshooting Your System."
E0CB2	MEM SPARE ROW	Correctable errors threshold was met in a memory bank; errors were remapped to the spare row.	See " <a href="#">Troubleshooting System Memory</a> " in "Troubleshooting Your System."
E0CF1	MBE DIMM Bank <i>n</i>	Memory modules installed in the specified bank are not the same type and size; faulty memory module(s).	Ensure that both memory modules in the bank are the same type and size and that they are properly installed. If the problem persists, see " <a href="#">Troubleshooting System Memory</a> " in "Troubleshooting Your System."
E0CF1	POST MEM 64K	Parity failure in the first 64 KB of main memory.	See " <a href="#">Troubleshooting System Memory</a> " in "Troubleshooting Your System."
E0CF1	POST NO MEMORY	Main-memory refresh verification failure.	See " <a href="#">Troubleshooting System Memory</a> " in "Troubleshooting Your System."
E0CF5	LOG DISABLE SBE	Multiple single-bit errors on a single memory module.	See " <a href="#">Troubleshooting System Memory</a> " in "Troubleshooting Your System."
E0D76	BP DRIVE FAIL <i>n</i>  1x2 DRIVE FAIL <i>n</i>	Faulty or improperly installed hard drive or RAID controller.	See " <a href="#">Troubleshooting SCSI Hard Drives</a> " " <a href="#">Troubleshooting a RAID Controller Card</a> ," and " <a href="#">Troubleshooting the Integrated RAID Controller</a> " in "Troubleshooting Your System."
E0F04	POST CMOS	CMOS write/read failure; faulty system board.	See " <a href="#">Getting Help</a> ."
E0F04	POST CPU SPEED	Microprocessor speed control sequence failure.	See " <a href="#">Getting Help</a> ."
E0F04	POST DMA INIT	DMA initialization failure; DMA page register write/read failure.	See " <a href="#">Troubleshooting System Memory</a> " in "Troubleshooting Your System."
E0F04	POST DMA REG	Faulty system board.	See " <a href="#">Getting Help</a> ."
E0F04	POST KYB CNTRL	Faulty keyboard controller; faulty system board.	See " <a href="#">Getting Help</a> ."
E0F04	POST MEM RFSH	Main-memory refresh verification failure.	See " <a href="#">Troubleshooting System Memory</a> " in "Troubleshooting Your System."
E0F04	POST PIC REG	Master or slave PIC register test failure.	See " <a href="#">Getting Help</a> ."
E0F04	POST SHADOW	BIOS-shadowing failure.	See " <a href="#">Troubleshooting System Memory</a> " in "Troubleshooting Your System."
E0F04	POST SHD TEST	Shutdown test failure.	
E0F04	POST SIO	Super I/O chip failure; faulty system board.	See " <a href="#">Getting Help</a> ."
E0F04	POST TIMER	Programmable interval timer test failure; faulty system board.	See " <a href="#">Getting Help</a> ."
E0F0B	POST ROM CHKSUM	Faulty or improperly installed expansion card.	See " <a href="#">Troubleshooting Expansion Cards</a> " in "Troubleshooting Your System."
E0F0C	VID MATCH CPU <i>n</i>	Specified microprocessor is faulty, unsupported, improperly installed, or missing.	See " <a href="#">Troubleshooting the Microprocessors</a> " in "Troubleshooting Your System."
E10F3	LOG DISABLE BIOS	BIOS disabled logging errors.	Check the SEL for details on the errors.
E13F2	IO CHANNEL CHECK	Faulty or improperly installed expansion card; faulty system board.	See " <a href="#">Troubleshooting Expansion Cards</a> " in "Troubleshooting Your System."
E13F4	PCI PARITY		
E13F5	PCI SYSTEM		
E13F8	CPU BUS INIT	Faulty or improperly installed microprocessor or system board.	See " <a href="#">Troubleshooting the Microprocessors</a> " in "Troubleshooting Your System." If the problem persists, see " <a href="#">Getting Help</a> ."
E13F8	CPU BUS PARITY	Faulty system board.	See " <a href="#">Getting Help</a> ."
E13F8	CPU MCKERR	Machine check error; faulty or improperly installed microprocessor; faulty system board.	See " <a href="#">Troubleshooting the Microprocessors</a> " in "Troubleshooting Your System."
E13F8	HOST BUS	Faulty system board.	See " <a href="#">Getting Help</a> ."
E13F8	HOST TO PCI BUS		
E13F8	MEM CONTROLLER	Faulty or improperly installed memory module; faulty system board.	See " <a href="#">Troubleshooting System Memory</a> " in "Troubleshooting Your System."
E1580	POWER CONTROL	Faulty system board.	See " <a href="#">Getting Help</a> ."

E20F1	OS HANG	Operating system watchdog timer timed out.	Restart your system. If the problem persists, see your operating system documentation.
EB107	MEMORY MIRRORED	Memory mirroring enabled	Information only.
EB107	MEMORY SPARED	Memory spare bank enabled	Information only.
EFFF0	RAC ERROR	Remote access controller firmware failure; faulty system board.	See " <a href="#">Getting Help</a> ."
EFFF1	POST ERROR	BIOS error.	Update the BIOS firmware (see " <a href="#">Getting Help</a> ").
EFFF2	BP ERROR	Faulty or improperly installed backplane board.	Ensure that the interface cables are securely connected to the backplane board (see " <a href="#">Installing Drives</a> "). If the problem persists, see " <a href="#">Getting Help</a> ."
<b>NOTE:</b> For the full name of an abbreviation or acronym used in this table, see the "Glossary" in the <i>User's Guide</i> .			

## System Messages

System messages appear on the screen during system boot to notify you of a possible problem with the system. [Table 2-8](#) lists the system messages that can occur and the probable cause and corrective action for each message.

 **NOTE:** If you receive a system message that is not listed in [Table 2-8](#), check the documentation for the application that is running when the message appears or the operating system's documentation for an explanation of the message and recommended action.

**Table 2-8. System Messages**

Message	Causes	Corrective Actions
Alert! Redundant memory disabled! Memory configuration does not support redundant memory.	The current memory configuration does not support redundant memory.	Install a memory configuration that supports redundant memory (spare bank feature). See " <a href="#">General Memory Module Installation Guidelines</a> " in "Installing System Components."
		Disable the <b>Redundant Memory</b> option in the System Setup program. See "Using the System Setup Program" in your <i>User's Guide</i> .
Amount of available memory limited to 256MB!	<b>OS Install Mode</b> is enabled in the System Setup program.	Disable <b>OS Install Mode</b> in the System Setup program. See "Using the System Setup Program" in your <i>User's Guide</i> .
Attempting to update Remote Configuration. Please wait....	Remote Configuration is in progress.	Wait until the process is complete.
BIOS Update Attempt Failed	BIOS remote update failed.	Retry update.
Caution! NVRAM_CLR jumper is installed on system board.	NVRAM_CLR jumper is installed.	Remove the NVRAM_CLR jumper. See <a href="#">Figure A-2</a> for the jumper location.
CD-ROM drive not found	Improperly connected or missing CD drive.	If no optical drive is installed, disable the IDE controller. See "Using the System Setup Program" in the User's Guide. If an optical drive is installed, see " <a href="#">Troubleshooting an Optical Drive</a> " in "Troubleshooting Your System."
CPUs with different cache sizes detected.	Mismatched processors are installed.	Install a correct version of the microprocessor so that both microprocessors have the same cache size. See " <a href="#">Replacing a Processor</a> " in "Installing System Components."
Decreasing available memory	Faulty or improperly installed memory modules.	Ensure that all memory modules are properly installed. See " <a href="#">Troubleshooting System Memory</a> " in "Troubleshooting Your System."
Diskette drive 0 seek failure	Incorrect configuration settings in System Setup program. Faulty or improperly installed diskette, loose diskette drive or optical drive interface cable, or loose power cable.	Run the System Setup program to correct the settings. See "Using the System Setup Program" in your <i>User's Guide</i> . Replace the diskette. Ensure that the diskette drive and optical drive cables are properly connected. See " <a href="#">Troubleshooting a Diskette Drive</a> ," and " <a href="#">Troubleshooting an Optical Drive</a> ," in "Troubleshooting Your System."
Diskette read failure	Faulty or improperly inserted diskette.	Replace the diskette.
Diskette subsystem reset failed	Faulty diskette drive or optical drive controller.	Ensure that the diskette drive and optical drive cables are properly connected. See " <a href="#">Troubleshooting a Diskette Drive</a> ," and " <a href="#">Troubleshooting an Optical Drive</a> ," in "Troubleshooting Your System." If the problem persists, see " <a href="#">Getting Help</a> ."
Drive not ready	Diskette missing or improperly inserted in diskette drive.	Reinsert or replace the diskette.
Embedded RAID error	An error has been generated by the firmware used by the optional integrated RAID controller.	Update the RAID firmware using the Dell Support website at <a href="#">support.dell.com</a> .
Embedded RAID firmware is not present	The firmware used by the optional integrated RAID controller is not responding to system requests.	Restore the RAID firmware using the Dell Support website at <a href="#">support.dell.com</a> .
Error: Incorrect memory configuration.	One or more unmatched	Ensure that the memory modules are installed in matched pairs. See " <a href="#">General</a>

Ensure memory in slots DIMM1_A and DIMM1_B, DIMM2_A and DIMM2_B, DIMM3_A and DIMM3_B match identically in size, speed, and rank.	pairs of memory modules are detected	<a href="#">Memory Module Installation Guidelines</a> in "Installing System Components."
Error: Incorrect memory configuration. Memory slots DIMM3_A and DIMM3_B only support single rank DIMMs. Remove the dual rank DIMMs from slots DIMM3_A and DIMM3_B.	Dual-rank memory modules are installed in slots DIMM3_A and DIMM3_B.	Ensure that only single-rank memory modules are installed in slots DIMM3_A and DIMM3_B. See " <a href="#">General Memory Module Installation Guidelines</a> " in "Installing System Components."
Error: Incorrect memory configuration. Move DIMM3_A and DIMM3_B into DIMM2_A and DIMM2_B.	Memory modules are not installed in consecutive banks.	Move memory modules from slots DIMM3_A and DIMM3_B into DIMM2_A and DIMM2_B. See " <a href="#">General Memory Module Installation Guidelines</a> " in "Installing System Components."
Error: Incorrect memory configuration. Swap the DIMMs in slots DIMM1_A and DIMM1_B with DIMMs in slots DIMM2_A and DIMM2_B.	If dual-rank memory modules are installed in the system, they must be installed in slots DIMM1_A and DIMM1_B.	Swap memory modules in slots DIMM2_A and DIMM2_B with modules in DIMM1_A and DIMM1_B. See " <a href="#">General Memory Module Installation Guidelines</a> " in "Installing System Components."
Error: Incorrect memory configuration. Memory slots DIMM3_A and DIMM3_B must be empty if dual rank memory DIMMs are in slots DIMM2_A and DIMM2_B.	Memory modules are installed in bank 3. Dual-rank memory modules are installed in banks 1 and 2.	Remove memory modules from slots DIMM3_A and DIMM3_B. See " <a href="#">General Memory Module Installation Guidelines</a> " in "Installing System Components."
Error: More than one RAC detected, system halted.	Two RACs are installed, or faulty or improperly installed RAC.	Ensure that only one RAC is installed. Ensure that the RAC is properly installed. See " <a href="#">Troubleshooting Expansion Cards</a> " in "Troubleshooting Your System," or " <a href="#">Installing a RAC Card</a> " in "Installing System Components."
Error: Remote Access Card initialization failure.	Faulty or improperly installed RAC.	Ensure that the RAC is properly installed. See " <a href="#">Troubleshooting Expansion Cards</a> " in "Troubleshooting Your System," or " <a href="#">Installing a RAC Card</a> " in "Installing System Components."
Error 8602: Auxiliary device failure. Verify that the keyboard and mouse are securely attached to correct connectors.	Loose or improperly connected mouse or keyboard cable; faulty mouse or keyboard.	Replace the mouse. If the problem persists, replace the keyboard.
Gate A20 failure	Faulty keyboard controller (faulty system board).	See " <a href="#">Getting Help</a> ."
General failure	Operating system corrupted or improperly installed.	Reinstall the operating system.
Keyboard controller failure	Faulty keyboard controller (faulty system board).	See " <a href="#">Getting Help</a> "
Keyboard data line failure	Loose or improperly connected keyboard cable; faulty keyboard; faulty keyboard controller.	Ensure that the keyboard is properly connected. If the problem persists, replace the keyboard. If the problem persists, see " <a href="#">Getting Help</a> ."
Keyboard failure		
Keyboard stuck key failure		
Keyboard fuse has failed.	Keyboard fuse has failed.	Replace the keyboard.
		Faulty system board. See " <a href="#">Getting Help</a> ."
Manufacturing mode detected	System is incorrectly configured.	After the message appears during system boot, press <Alt><F> to turn off manufacturing mode.
Memory address line failure at <i>address</i> , read value expecting value	Faulty or improperly installed memory modules, or faulty system board.	Ensure that all memory modules are properly installed. See " <a href="#">Troubleshooting System Memory</a> " in "Troubleshooting Your System." If the problem persists, see " <a href="#">Getting Help</a> ."
Memory double word logic failure at <i>address</i> , read value expecting value		
Memory odd/even logic failure at <i>start address</i> to <i>end address</i>		
Memory write/read failure at <i>address</i> , read value expecting value		
Memory mirroring enabled	Memory mirroring enabled	You can enable memory mirroring using the System Setup program if the memory is configured to support mirroring. For more information, see " <a href="#">General Memory Module Installation Guidelines</a> " in "Installing System Components," and Using the System Setup Program" in your <i>User's Guide</i> .
Memory tests terminated by keystroke	The spacebar was pressed during POST to terminate the memory test.	Information only.
No boot device available	Faulty or missing diskette drive, optical drive, or hard drive.	Check the <b>Integrated Devices</b> configuration settings in the System Setup program. See "Using the System Setup Program" in your <i>User's Guide</i> . Ensure that either <b>SCSI Controller</b> , <b>Diskette Controller</b> , or <b>IDE CD-ROM Controller</b> is enabled. If the system is booting from a SCSI controller, ensure that the controller is properly connected. If the problem persists, replace the drive. See " <a href="#">Installing Drives</a> ."
No boot sector on hard-disk drive	An operating system is not on the hard drive.	Check the hard-drive configuration settings in the System Setup program. See "Using the System Setup Program" in your <i>User's Guide</i> .
No timer tick interrupt	Faulty system board.	See " <a href="#">Getting Help</a> ."
Not a boot diskette	Not a bootable diskette.	Use a bootable diskette.
PCI BIOS failed to install	Loose cables to expansion card(s); faulty or improperly installed expansion card.	Ensure that all appropriate cables are securely connected to the expansion cards. See " <a href="#">Troubleshooting Expansion Cards</a> ," in "Troubleshooting Your System."
PCIe Degraded Link Width Error: Embedded	Faulty or improperly installed	Reseat the PCIe cards and the expansion-card cage. See " <a href="#">Installing the</a>

Bus#nn/Dev#nn/Funcn Expected Link Width is n Actual Link Width is n	PCIe card or expansion-card cage.	<a href="#">Expansion-Card Cage</a> and <a href="#">Expansion Cards</a> If the problem persists, see <a href="#">Getting Help</a> ."
PCIe Degraded Link Width Error: Slot n Expected Link Width is n Actual Link Width is n	Faulty or improperly installed PCIe card in the specified slot number.	Reseat the PCIe card in the specified slot number. See <a href="#">Expansion Cards</a> ." If the problem persists, see <a href="#">Getting Help</a> ."
PCIe Training Error: Embedded Bus#nn/Dev#nn/Funcn	Faulty or improperly installed PCIe card or expansion-card cage.	Reseat the PCIe cards and the expansion-card cage. See <a href="#">Installing the Expansion-Card Cage</a> and <a href="#">Expansion Cards</a> ." If the problem persists, see <a href="#">Getting Help</a> ."
PCIe Training Error: Slot n	Faulty or improperly installed PCIe card in the specified slot number.	Reseat the PCIe card in the specified slot number. See <a href="#">Expansion Cards</a> ." If the problem persists, see <a href="#">Getting Help</a> ."
Plug & Play Configuration Error	Error encountered in initializing PCI device; faulty system board.	Install the NVRAM_CLR jumper and reboot the system. See <a href="#">Figure A-2</a> for jumper location. Check for a BIOS update. If the problem persists, see <a href="#">Troubleshooting Expansion Cards</a> in "Troubleshooting Your System." If the problem persists, see <a href="#">Getting Help</a> ."
Read fault Requested sector not found	Faulty diskette, diskette drive, optical drive, or hard drive.	Replace the diskette. Ensure that the diskette, optical, and hard-drive cables are properly connected. See <a href="#">Troubleshooting a Diskette Drive</a> ," <a href="#">Troubleshooting an Optical Drive</a> ," or <a href="#">Troubleshooting SCSI Hard Drives</a> ," in "Troubleshooting Your System" for the appropriate drive(s) installed in your system.
Remote Configuration update attempt failed	System could not implement Remote Configuration request.	Retry Remote Configuration.
ROM bad checksum = address	Faulty or improperly installed expansion card.	Remove and reseat the expansion cards. See <a href="#">Troubleshooting Expansion Cards</a> in "Troubleshooting Your System."
Sector not found Seek error Seek operation failed	Faulty diskette or hard drive.	Replace the diskette. If the problem persists, see <a href="#">Troubleshooting SCSI Hard Drives</a> in "Troubleshooting Your System" for the appropriate drive installed in your system.
Shutdown failure	Shutdown test failure.	Ensure that all memory modules are properly installed. See <a href="#">Troubleshooting System Memory</a> in "Troubleshooting Your System." If the problem persists, see <a href="#">Getting Help</a> ."
Spare bank enabled	Memory spare bank enabled.	You can enable memory spare bank using the System Setup program if the memory is configured to support this feature. For more information, see <a href="#">General Memory Module Installation Guidelines</a> in "Installing System Components," and Using the System Setup Program in your <i>User's Guide</i> .
The amount of system memory has changed.	Faulty memory module.	See <a href="#">Troubleshooting System Memory</a> in "Troubleshooting Your System." If the problem persists, see <a href="#">Getting Help</a> ."
	Information only, if you have changed the memory configuration.	
Time-of-day clock stopped	Faulty battery; faulty system board.	See <a href="#">Troubleshooting the System Battery</a> in "Troubleshooting Your System." If the problem persists, see <a href="#">Getting Help</a> ."
Time-of-day not set - please run SETUP program	Incorrect <b>Time</b> or <b>Date</b> settings; faulty system battery.	Check the <b>Time</b> and <b>Date</b> settings See "Using the System Setup Program" in your <i>User's Guide</i> . If the problem persists, see <a href="#">Troubleshooting the System Battery</a> in "Troubleshooting Your System."
Timer chip counter 2 failed	Faulty system board.	See <a href="#">Getting Help</a> ."
Unsupported RAID key detected.	A RAID key intended for use with another system is installed.	Replace the RAID key.
Unexpected interrupt in protected mode	Faulty or improperly installed memory modules or faulty system board.	Ensure that all memory modules are properly installed. See <a href="#">General Memory Module Installation Guidelines</a> in "Installing System Components." If the problem persists, see <a href="#">Troubleshooting System Memory</a> in "Troubleshooting Your System." If the problem persists, see <a href="#">Getting Help</a> ."
Unsupported CPU combination	Mismatched processors are installed.  Processor is not supported by the system.	Replace a microprocessor so that both microprocessors match. See "Adding or Replacing a Microprocessor" in "Installing System Components."  Check for a BIOS update using the Dell Support website at <a href="#">support.dell.com</a> . If the problem persists, install a supported processor. See <a href="#">Replacing a Processor</a> in "Installing System Components."
Unsupported CPU stepping detected	Processor is not supported by the system.	Check for a BIOS update using the Dell Support website at <a href="#">support.dell.com</a> . If the problem persists, install a supported processor. See <a href="#">Replacing a Processor</a> in "Installing System Components."
Utility partition not available	<F10> key was pressed during POST, but no utility partition exists on the boot hard drive.	Create a utility partition on the boot hard drive. See "Using the Dell OpenManage Server Assistant CD" in your <i>User's Guide</i> .
Warning: Detected mode change from RAID to SCSI x of the embedded RAID subsystem.	Type of controller has changed from optional RAID to SCSI since previous system boot.	Back up information on the hard drives before changing the type of controller used with the drives.
Warning: Detected mode change from SCSI to RAID x of the embedded RAID subsystem.	Type of controller has changed from SCSI to optional RAID since previous system boot.	Back up information on the hard drives before changing the type of controller used with the drives.

Warning! No microcode update loaded for processor <i>n</i>	Unsupported processor.	Update the BIOS firmware using the Dell Support website at <a href="http://support.dell.com">support.dell.com</a> .
Write fault Write fault on selected drive	Faulty diskette, diskette drive, optical drive, hard drive.	Replace the diskette. Ensure that the diskette drive, optical drive, and hard-drive cables are properly connected. See " <a href="#">Troubleshooting a Diskette Drive</a> ," " <a href="#">Troubleshooting an Optical Drive</a> ," or " <a href="#">Troubleshooting SCSI Hard Drives</a> " in "Troubleshooting Your System" for the appropriate drive(s) installed in your system.

## System Beep Codes

If an error that cannot be reported on the screen occurs during POST, the system may emit a series of beeps that identifies the problem.

 **NOTE:** If the system boots without a keyboard, mouse, or monitor attached, the system does not issue beep codes related to those peripherals.

If a beep code is emitted, write down the series of beeps and then look it up in [Table 2-9](#). If you are unable to resolve the problem by looking up the meaning of the beep code, use system diagnostics to identify the possible cause. If you are still unable to resolve the problem, see "[Getting Help](#)."

**Table 2-9. System Beep Codes**

Code	Cause	Corrective Action
1-1-2	CPU register test failure	See " <a href="#">Troubleshooting the Microprocessors</a> " in "Troubleshooting Your System."
1-1-3	CMOS write/read failure; faulty system board	Faulty system board. See " <a href="#">Getting Help</a> ."
1-1-4	BIOS error	Reflash the BIOS.
1-2-1	Programmable interval-timer failure; faulty system board	Faulty system board. See " <a href="#">Getting Help</a> ."
1-2-2	DMA initialization failure	See " <a href="#">Troubleshooting System Memory</a> " in "Troubleshooting Your System."
1-2-3	DMA page register write/read failure	
1-3-1	Main-memory refresh verification failure	
1-3-2	No memory installed	
1-3-3	Chip or data line failure in the first 64 KB of main memory	
1-3-4	Odd/even logic failure in the first 64 KB of main memory	
1-4-1	Address line failure in the first 64 KB of main memory	
1-4-2	Parity failure in the first 64 KB of main memory	
1-4-3	Fail-safe timer test failure	
1-4-4	Software NMI port test failure	
2-1-1 through 2-4-4	Bit failure in the first 64 KB of main memory	Faulty system board. See " <a href="#">Getting Help</a> ."
3-1-1	Slave DMA-register failure	
3-1-2	Master DMA-register failure	
3-1-3	Master interrupt-mask register failure	
3-1-4	Slave interrupt-mask register failure	
3-2-2	Interrupt vector loading failure	
3-2-4	Keyboard-controller test failure	
3-3-1	CMOS failure	
3-3-2	System configuration check failure	
3-3-3	Keyboard controller not detected	
3-3-4	Video memory test failure	
3-4-1	Screen initialization failure	
3-4-2	Screen-retrace test failure	
3-4-3	Video ROM search failure	
4-2-1	No timer tick	Faulty system board. See " <a href="#">Getting Help</a> ."
4-2-2	Shutdown test failure	
4-2-3	Gate A20 failure	
4-2-4	Unexpected interrupt in protected mode	See " <a href="#">Troubleshooting Expansion Cards</a> " in "Troubleshooting Your System."
4-3-1	Improperly installed or faulty memory modules	See " <a href="#">Troubleshooting System Memory</a> " in "Troubleshooting Your System."
4-3-2	No memory modules installed in the first memory module connector	Install a memory module in the first memory module connector. See " <a href="#">System Memory</a> " in "Installing System Components."
4-3-3	Faulty system board	Faulty system board. See " <a href="#">Getting Help</a> ."
4-3-4	Time-of-day clock stopped	See " <a href="#">Troubleshooting System Memory</a> " in "Troubleshooting Your System." If the problem persists, see " <a href="#">Getting Help</a> ."

4-4-1	Super I/O chip failure; faulty system board	Faulty system board. See " <a href="#">Getting Help</a> ."
4-4-4	Cache test failure; faulty processor	See " <a href="#">Troubleshooting the Microprocessors</a> " in "Troubleshooting Your System."

---

## Warning Messages

A warning message alerts you to a possible problem and prompts you to respond before the system continues a task. For example, before you format a diskette, a message will warn you that you may lose all data on the diskette. Warning messages usually interrupt the task and require you to respond by typing y (yes) or n (no).

 **NOTE:** Warning messages are generated by either the application or the operating system. For more information, see "[Finding Software Solutions](#)" and the documentation that accompanied the operating system or application.

---

## Diagnostics Messages

When you run system diagnostics, an error message may result. Diagnostic error messages are not covered in this section. Record the message on a copy of the Diagnostics Checklist in "Getting Help," and then follow the instructions in that section for obtaining technical assistance.

---

## Alert Messages

Systems management software generates alert messages for your system. Alert messages include information, status, warning, and failure messages for drive, temperature, fan, and power conditions. For more information, see the systems management software documentation.

---

## Baseboard Management Controller Messages

The Baseboard Management Controller (BMC) enables you to configure, monitor, and recover systems remotely. BMC uses the system's serial port and integrated NIC1 to support fault logging and SNMP alerting.

 **NOTE:** If the integrated network controller is used in an Ether Channel team or link aggregation team, the BMC management traffic will not function properly. For more information about network teaming, see the documentation for the network controller.

For additional information on using BMC, see the documentation for the BMC and systems management applications.

---

[Back to Contents Page](#)

[Back to Contents Page](#)

## Finding Software Solutions

### Dell™ PowerEdge™ 2800 Systems Installation and Troubleshooting Guide

- [Before You Begin](#)
- [Troubleshooting Errors and Conflicts](#)

Software problems can be caused by:

- 1 Improper installation or configuration of an application
- 1 Application conflicts
- 1 Input errors
- 1 Interrupt assignment conflicts

Ensure that you are installing the software application according to the software manufacturer's recommended procedures. If a problem occurs after you install the software, you might need to troubleshoot your software application and your system.

See the documentation that accompanied the software or contact the software manufacturer for detailed troubleshooting information.

 **NOTE:** If all of the system diagnostic tests complete successfully, then the problem is most likely caused by the software and not the hardware.

---

## Before You Begin

- 1 Scan the software media with antivirus software.
- 1 Read the software documentation before you run the installation utility.
- 1 Be prepared to respond to prompts from the installation utility.

The installation utility may require you to enter information about your system, such as how the operating system is configured, and the type of peripherals that are connected to the system. Have this information available before running the installation utility.

---

## Troubleshooting Errors and Conflicts

While configuring and running software, problems might occur that are caused by input errors, application conflicts, and/or IRQ assignment conflicts. The problems are sometimes indicated by error messages.

Error messages are generated by system hardware or software. "[Indicators, Messages, and Codes](#)" provides information about error messages that are hardware-based. If you receive an error message that is not listed, see your operating system or software program documentation for troubleshooting information.

## Input Errors

Pressing a specific key or set of keys at the wrong time may produce unexpected results. See the documentation that came with the software application to ensure that the values or characters you are entering are valid.

Ensure that your operating system is configured properly to run the application. Remember that whenever you change the parameters of the operating system, the changes can conflict with an application's operating requirements. After you configure the operating system, you may need to reinstall or reconfigure a software application so that it can run properly in its new environment.

## Application Conflicts

Some applications can leave unnecessary files or data behind after they are deleted from your system. Device drivers can also create application errors. If application errors occur, see your application device driver or operating system documentation for troubleshooting information.

## IRQ Assignment Conflicts

Most PCI devices can share an IRQ, but they cannot use an IRQ simultaneously. To avoid this type of conflict, see the documentation for each PCI device for specific IRQ requirements.

**Table 3-1.** IRQ Assignment Defaults

IRQ Line	Assignment
IRQ0	System timer
IRQ1	Keyboard controller

IRQ2	Interrupt controller 1 to enable IRQ8 through IRQ15
IRQ3	<i>Available</i>
IRQ4	Serial port 1 (COM1 and COM3)
IRQ5	Remote access controller
IRQ6	Diskette drive controller
IRQ7	Parallel port
IRQ8	Real-time clock
IRQ9	ACPI functions (used for power management)
IRQ10	<i>Available</i>
IRQ11	<i>Available</i>
IRQ12	PS/2 mouse port unless the mouse is disabled through the System Setup program
IRQ13	Math coprocessor
IRQ14	IDE optical drive controller
IRQ15	<i>Available</i>

---

[Back to Contents Page](#)



[Back to Contents Page](#)

## Running the System Diagnostics

Dell™ PowerEdge™ 2800 Systems Installation and Troubleshooting Guide

- [Using Server Administrator Diagnostics](#)
- [System Diagnostics Features](#)
- [When to Use the System Diagnostics](#)
- [Running the System Diagnostics](#)
- [System Diagnostics Testing Options](#)
- [Using the Custom Test Options](#)

If you experience a problem with your system, run the diagnostics before calling for technical assistance. The purpose of the diagnostics is to test your system's hardware without requiring additional equipment or risking data loss. If you are unable to fix the problem yourself, service and support personnel can use diagnostics test results to help you solve the problem.

---

### Using Server Administrator Diagnostics

To assess a system problem, first use the online Server Administrator diagnostics. If you are unable to identify the problem, then use the system diagnostics.

To access the online diagnostics, log into the Server Administrator home page, and then click the **Diagnostics** tab. For information about using diagnostics, see the online help. For additional information, see the *Server Administrator User's Guide*.

---

### System Diagnostics Features

The system diagnostics provides a series of menus and options for particular device groups or devices. The system diagnostics menus and options allow you to:

- 1 Run tests individually or collectively.
  - 1 Control the sequence of tests.
  - 1 Repeat tests.
  - 1 Display, print, or save test results.
  - 1 Temporarily suspend testing if an error is detected or terminate testing when a user-defined error limit is reached.
  - 1 View help messages that briefly describe each test and its parameters.
  - 1 View status messages that inform you if tests are completed successfully.
  - 1 View error messages that inform you of problems encountered during testing.
- 

### When to Use the System Diagnostics

If a major component or device in the system does not operate properly, component failure may be indicated. As long as the microprocessor and the system's input/output devices (monitor, keyboard, and diskette drive) are functioning, you can use the system diagnostics to help identify the problem.

---

### Running the System Diagnostics

The system diagnostics can be run either from the utility partition on your hard drive or from a set of diskettes that you create using the *Dell OpenManage Server Assistant* CD. To use diskettes you must either have the optional diskette drive installed in your system, or a USB diskette drive.

- ➔ **NOTICE:** Use the system diagnostics to test only your system. Using this program with other systems may cause invalid results or error messages. In addition, use only the program that came with your system (or an updated version of that program).

#### From the Utility Partition

1. As the system boots, press <F10> during POST.
2. From the utility partition main menu under **Run System Utilities**, select **Run System Diagnostics**, or select **Run Memory Diagnostics** if you are troubleshooting memory.

#### From the Diagnostics Diskettes

1. Create a set of diagnostics diskettes from the *Dell OpenManage Server Assistant* CD. See "Using the Dell OpenManage Server Assistant CD" in your *User's Guide* for information on creating the diskettes.
2. If your system does have the optional diskette drive installed, obtain a USB diskette drive and connect it to the system.
3. Insert the first system diagnostics diskette, or the **MP Memory** diskette (if you are troubleshooting memory).
4. Reboot the system.

If the system fails to boot, see "Getting Help."

When you start the system diagnostics, a message is displayed stating that the diagnostics are initializing. Next, the **Diagnostics** menu appears. The menu allows you to run all or specific diagnostics tests or to exit the system diagnostics.

 **NOTE:** Before you read the rest of this section, start the system diagnostics so that you can see the utility on your screen.

## System Diagnostics Testing Options

Click the testing option in the **Main Menu** window. [Table 4-1](#) provides a brief explanation of testing options.

**Table 4-1.** System Diagnostics Testing Options

Testing Option	Function
Express Test	Performs a quick check of the system. This option runs device tests that do not require user interaction. Use this option to quickly identify the source of your problem.
Extended Test	Performs a more thorough check of the system. This test can take an hour or longer.
Custom Test	Tests a particular device.
Information	Displays test results.

## Using the Custom Test Options

When you select **Custom Test** in the **Main Menu** window, the **Customize** window appears and allows you to select the device(s) to be tested, select specific options for testing, and view the test results.

## Selecting Devices for Testing

The left side of the **Customize** window lists devices that can be tested. Devices are grouped by device type or by module, depending on the option you select. Click the **(+)** next to a device or module to view its components. Click **(+)** on any component to view the tests that are available. Clicking a device, rather than its components, selects all of the components of the device for testing.

## Selecting Diagnostics Options

Use the **Diagnostics Options** area to select how you want to test a device. You can set the following options:

- 1 **Non-Interactive Tests Only** — When checked, runs only tests that require no user intervention.
- 1 **Quick Tests Only** — When checked, runs only the quick tests on the device. Extended tests will not run when you select this option.
- 1 **Show Ending Timestamp** — When checked, time stamps the test log.
- 1 **Test Iterations** — Selects the number of times the test is run.
- 1 **Log output file pathname** — When checked, enables you to specify where the test log file is saved.

## Viewing Information and Results

The tabs in the **Customize** window provide information about the test and the test results. The following tabs are available:

- 1 **Results** — Displays the test that ran and the result.
- 1 **Errors** — Displays any errors that occurred during the test.
- 1 **Help** — Displays information about the currently selected device, component, or test.
- 1 **Configuration** — Displays basic configuration information about the currently selected device.
- 1 **Parameters** — If applicable, displays parameters that you can set for the test.

---

[Back to Contents Page](#)

## Troubleshooting Your System

### Dell™ PowerEdge™ 2800 Systems Installation and Troubleshooting Guide

- [Safety First—For You and Your System](#)
- [Start-Up Routine](#)
- [Checking Basic Power Problems](#)
- [Checking the Equipment](#)
- [Troubleshooting Basic I/O Functions](#)
- [Troubleshooting a NIC](#)
- [Responding to a Systems Management Software Alert Message](#)
- [Inside the System](#)
- [Opening the System](#)
- [Closing the System](#)
- [Troubleshooting a Wet System](#)
- [Troubleshooting a Damaged System](#)
- [Troubleshooting the System Battery](#)
- [Troubleshooting Redundant Power Supplies](#)
- [Troubleshooting System Cooling Problems](#)
- [Troubleshooting System Memory](#)
- [Troubleshooting a Diskette Drive](#)
- [Troubleshooting an Optical Drive](#)
- [Troubleshooting a SCSI Tape Drive](#)
- [Troubleshooting SCSI Hard Drives](#)
- [Troubleshooting the Integrated RAID Controller](#)
- [Troubleshooting a RAID Controller Card](#)
- [Troubleshooting Expansion Cards](#)
- [Troubleshooting the Microprocessors](#)

---

## Safety First—For You and Your System

To perform certain procedures in this document, you must remove the system cover and work inside the system. While working inside the system, do not attempt to service the system except as explained in this guide and elsewhere in your system documentation.

**⚠ CAUTION:** Only trained service technicians are authorized to remove the system cover and access any of the components inside the system. See your *Product Information Guide* for complete information about safety precautions, working inside the computer, and protecting against electrostatic discharge.

---

## Start-Up Routine

Look and listen during the system's start-up routine for the indications described in [Table 5-1](#).

**Table 5-1. Start-Up Routine Indications**

Look/listen for:	Action
An error message displayed on the monitor.	See " <a href="#">System Messages</a> " in "Indicators, Codes, and Messages."
A series of beeps emitted by the system.	See " <a href="#">System Beep Codes</a> " in "Indicators, Codes, and Messages."
Alert messages from the systems management software.	See the systems management software documentation.
The monitor's power indicator.	See " <a href="#">Troubleshooting the Video Subsystem</a> ."
The keyboard indicators.	See " <a href="#">Troubleshooting the Keyboard</a> ."
The diskette drive activity indicator.	See " <a href="#">Troubleshooting a Diskette Drive</a> ."
The optical drive activity indicator.	See " <a href="#">Troubleshooting an Optical Drive</a> ."
The hard-drive activity indicator.	See " <a href="#">Troubleshooting SCSI Hard Drives</a> ."
An unfamiliar constant scraping or grinding sound when you access a drive.	See " <a href="#">Getting Help</a> ."

---

## Checking Basic Power Problems

1. If the power indicator on the system front panel or power supply does not indicate that power is available to the system, ensure that the power cable is securely connected to the power supply.
2. If the system is connected to a PDU or UPS, turn the PDU or UPS off and then on.
3. If the PDU or UPS is not receiving power, plug it into another electrical outlet. If it still is not receiving power, try another PDU or UPS.
4. Reconnect the system to the electrical outlet and turn on the system.

If the system still is not working properly, see "[Troubleshooting Redundant Power Supplies](#)."

---

## Checking the Equipment

This section provides troubleshooting procedures for external devices attached to the system, such as the monitor, keyboard, or mouse. Before you perform any of the procedures, see "[Troubleshooting External Connections](#)."

## Troubleshooting External Connections

Loose or improperly connected cables are the most likely source of problems for the system, monitor, and other peripherals (such as a printer, keyboard, mouse, or other external device). Ensure that all external cables are securely attached to the external connectors on your system. See [Figure 2-1](#) and [Figure 2-2](#) for the front-panel and back-panel connectors on your system.

## Troubleshooting the Video Subsystem

### Problem

- 1 Monitor is not working properly.
- 1 Video memory is faulty.

### Action

1. Check the system and power connections to the monitor.
2. Run the appropriate online diagnostic test. See "[Using Server Administrator Diagnostics](#)" in "Running System Diagnostics."  
If the tests run successfully, the problem is not related to video hardware. See "[Finding Software Solutions](#)."  
If the tests fail, see "[Getting Help](#)."

## Troubleshooting the Keyboard

### Problem

- 1 System message indicates a problem with the keyboard.
- 1 Keyboard is not functioning properly.

### Action

1. Run the appropriate online diagnostic test. See "[Using Server Administrator Diagnostics](#)" in "Running System Diagnostics."
2. Examine the keyboard and its cable for signs of damage.
3. Swap the faulty keyboard with a working keyboard.  
If the problem is resolved, replace the faulty keyboard.
4. If the keyboard is a USB keyboard, enter the System Setup program and ensure that the USB ports are enabled. See "Using the System Setup Program" in your *User's Guide*.  
If the problem is not resolved, see "[Getting Help](#)."

## Troubleshooting the Mouse

### Problem

- 1 System message indicates a problem with the mouse.
- 1 Mouse is not functioning properly.

### Action

1. Run the appropriate online diagnostic test. See "Using Server Administrator Diagnostics" in "Running System Diagnostics."  
If the test fails, continue to the next step.
  2. Examine the mouse and its cable for signs of damage.  
If the mouse is not damaged, go to [step 5](#).  
If the mouse is damaged, continue to the next step.
  3. Swap the faulty mouse with a working mouse.  
If the problem is resolved, replace the faulty mouse.
  4. If the mouse is a USB mouse, enter the System Setup program and ensure that the USB ports are enabled. See "Using the System Setup Program" in your *User's Guide*.
  5. If the problem is not resolved, see "[Getting Help](#)."
- 

## Troubleshooting Basic I/O Functions

### Problem

1. Error message indicates a problem with the serial port.
1. Device connected to the serial port is not operating properly.

### Action

1. Enter the System Setup program and ensure that the serial port is enabled. See "Using the System Setup Program" in the *User's Guide*.
2. If the problem is confined to a particular application, see the application documentation for specific port configuration requirements that the program may require.
3. Run the appropriate online diagnostic test. See "[Using Server Administrator Diagnostics](#)" in "Running System Diagnostics."  
If the tests run successfully but the problem persists, see the appropriate procedure—"Troubleshooting a Serial I/O Device" or "[Troubleshooting a Non-USB Parallel Printer](#)."

## Troubleshooting a Serial I/O Device

### Problem

1. Device connected to the serial port is not operating properly.

### Action

1. Turn off the system and any peripheral devices connected to the serial port.
2. Swap the serial interface cable with a working cable, and turn on the system and the serial device.  
If the problem is resolved, replace the interface cable.
3. Turn off the system and the serial device, and swap the device with a comparable device.
4. Turn on the system and the serial device.  
If the problem is resolved, replace the serial device.  
If the problem persists, see "[Getting Help](#)."

## Troubleshooting a USB Device

### Problem

- 1 System message indicates a problem with a USB device.
- 1 Device connected to a USB port is not operating properly.

### Action

1. Enter the System Setup program, and ensure that the USB ports are enabled. See "Using the System Setup Program" in your *User's Guide*.
2. Turn off the system and any USB devices.
3. Disconnect the USB devices, and connect the malfunctioning device to another USB connector.

4. Turn on the system and the reconnected device.

If the problem is resolved, the USB connector might be defective. See "[Getting Help](#)."

5. If possible, swap the interface cable with a working cable.

If the problem is resolved, replace the interface cable.

6. Turn off the system and the USB device, and swap the device with a comparable device.

7. Turn on the system and the USB device.

If the problem is resolved, replace the USB device.

If the problem persists, see "[Getting Help](#)."

## Troubleshooting a Non-USB Parallel Printer

### Problem

- 1 Parallel printer is not operating properly.
- 1 Parallel printer interface cable.

### Action

1. Turn off the system and the parallel printer.
2. Swap the parallel printer interface cable with a known working cable, and turn on the system and the printer.
3. Attempt a print operation.
4. If the print operation is successful, replace the interface cable (see "[Getting Help](#)").
5. Run the printer's self-test.
6. If the self-test fails, the printer is malfunctioning (see "[Getting Help](#)").

 **CAUTION:** Only trained service technicians are authorized to remove the system cover and access any of the components inside the system. See your *Product Information Guide* for complete information about safety precautions, working inside the computer, and protecting against electrostatic discharge.

7. Open the system. See "[Opening the System](#)."

Ensure that the cable leading to the parallel port on the system back panel is properly connected to the parallel port connector on the system board. See [Figure A-3](#).

8. Close the system. See "[Closing the System](#)."
  9. Reconnect the system to the electrical outlet, and turn on the system and attached peripherals.
  10. If the problem is not resolved, see "[Getting Help](#)."
- 

## Troubleshooting a NIC

### Problem

1. NIC cannot communicate with network.

### Action

1. Run the appropriate online diagnostic test. See "[Using Server Administrator Diagnostics](#)" in "Running System Diagnostics."
  2. Enter the System Setup program and confirm that the NICs are enabled. See "Using the System Setup Program" in your *User's Guide*.
  3. Check the appropriate indicator on the NIC connector. See "[NIC Indicator Codes](#)" in "Indicators, Messages, and Codes."
    1. If the link indicator does not light, check all cable connections.
    1. If the activity indicator does not light, the network driver files might be damaged or missing.  
Remove and reinstall the drivers if applicable. See the NIC's documentation.
    1. Use another connector on the switch or hub.If you are using a NIC card instead of an integrated NIC, see the documentation for the NIC card.
  4. Ensure that the appropriate drivers are installed and the protocols are bound. See the NIC's documentation.
  5. Ensure that the NICs, hubs, and switches on the network are all set to the same data transmission speed. See the network equipment documentation.
  6. Ensure that all network cables are of the proper type and do not exceed the maximum length. See "Network Cable Requirements" in your *User's Guide*.
- 

## Responding to a Systems Management Software Alert Message

Systems management software monitors critical system voltages and temperatures, fans, and hard drives in the system. Alert messages appear in the **Alert Log** window. For information about the **Alert Log** window, see the systems management software documentation.

---

## Inside the System

In [Figure 5-1](#), the bezel and system cover are removed to provide an interior view of the system.

**Figure 5-1. Inside the System**



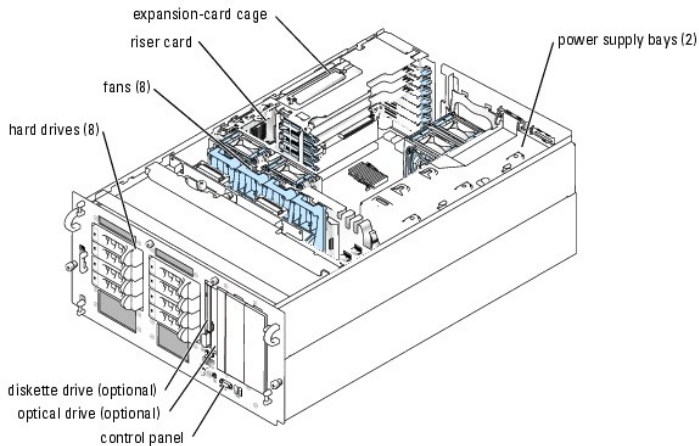

The system board holds the system's control circuitry and other electronic components. The processor and memory are installed directly on the system board. Using a riser card, the system can accommodate up to seven expansion cards.

The SCSI backplane supports up to eight SCSI hard drives. A removable drive carrier supports an optional diskette drive and optional optical drive. The peripheral bays provide space for two half-height or one full-height 5 1/4-inch form factor devices, or two additional SCSI hard drives and a half-height 5 1/4-inch form factor device. Power is supplied to the system board and drives through one or two (optional) power supplies.

## Opening the System

The system is enclosed by an optional bezel and cover. To upgrade or troubleshoot the system, remove the bezel and cover to access the drives and internal system components.

**NOTE:** The following procedure applies to rack systems. The procedure for a tower system is similar, except the keylock and release latch are at the upper edge of the bezel when the system is upright.

1. If applicable, remove the bezel. See [Figure 5-2](#).
  - a. Unlock the keylock at the left end of the bezel.
  - b. While grasping the bezel, depress the release latch on the left edge of the bezel, adjacent to the keylock.
  - c. Rotate the left end of the bezel away from the front panel.
  - d. Unhook the right end of the bezel and pull the bezel away from the system.

**Figure 5-2. Installing and Removing the Optional Bezel**

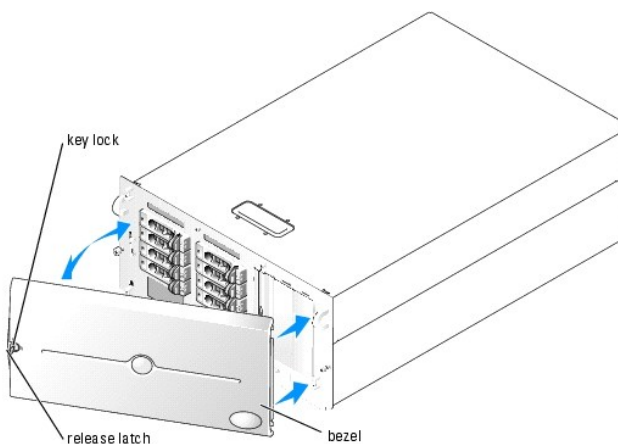

**CAUTION:** Only trained service technicians are authorized to remove the system cover and access any of the components inside the system. See your *Product Information Guide* for complete information about safety precautions, working inside the computer, and protecting against electrostatic discharge.

2. Unless you are installing a hot-plug component such as a cooling fan or hot-plug expansion card, turn off the system and attached peripherals, and disconnect the system from the electrical outlet and peripherals.

3. If you are working with a tower system, place the system on its side as shown in [Figure 5-2](#).
4. To remove the system cover, loosen the two thumbscrews at the front of the system. See [Figure 5-3](#).
5. Slide the cover backward about 1.3 cm (0.5 inch), and grasp the cover on both sides.
6. Carefully lift the cover away from the system.

**Figure 5-3. Installing and Removing the System Cover**

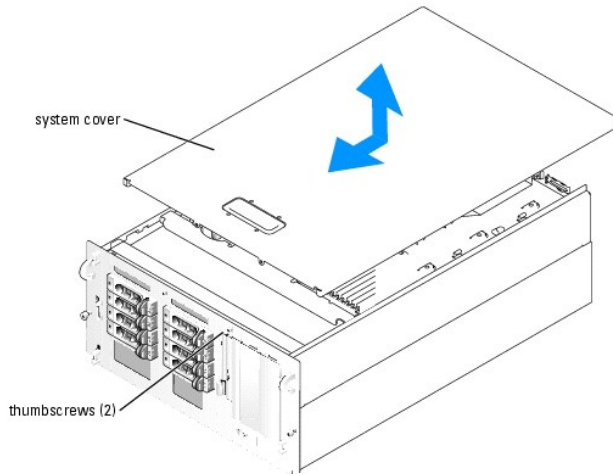

---

## Closing the System

1. Ensure that you did not leave tools or parts inside the system.
2. Place the cover over the sides of the chassis, and slide the cover forward.
3. Tighten the two thumbscrews at the front of the system to secure the cover. See [Figure 5-3](#).
4. Reconnect the peripheral cables.
5. Reconnect the system to the electrical outlet, and turn on the system.
6. To replace the optional bezel, hook the right end of the bezel onto the chassis, then fit the free end of the bezel onto the system. Secure the bezel with the keylock. See [Figure 5-2](#).

---

## Troubleshooting a Wet System

### Problem

1. Liquid spilled on the system.
1. Excessive humidity.

### Action

**⚠ CAUTION:** Only trained service technicians are authorized to remove the system cover and access any of the components inside the system. See your *Product Information Guide* for complete information about safety precautions, working inside the computer, and protecting against electrostatic discharge.

1. Turn off the system and attached peripherals, and disconnect the system from the electrical outlet.

2. Open the system. See "[Opening the System](#)."
  3. Remove the expansion card cage from the system. See "[Removing the Expansion-Card Cage](#)" in "Installing System Components."
  4. Remove all expansion cards installed in the system. See "[Removing an Expansion Card](#)" in "Installing System Components."
  5. Remove all memory modules installed in the system. See "[Removing Memory Modules](#)" in "Installing System Components."
  6. Remove the processor(s) from the system. See "[Replacing a Processor](#)" in "Installing System Components."
  7. Let the system dry thoroughly for at least 24 hours.
  8. Replace the processor(s), memory modules, and expansion cards. See "[Replacing a Processor](#)," "[Installing Memory Modules](#)," and "[Installing an Expansion Card](#)" in "Installing System Components."
  9. Replace the expansion card cage. See "[Installing the Expansion-Card Cage](#)" in "Installing System Components."
  10. Close the system. See "[Closing the System](#)."
  11. Reconnect the system to the electrical outlet, and turn on the system and peripherals.  
If the system does not start properly, see "[Getting Help](#)."
  12. Run the appropriate online diagnostic test. See "[Using Server Administrator Diagnostics](#)" in "Running the System Diagnostics."  
If the tests fail, see "[Getting Help](#)."
- 

## Troubleshooting a Damaged System

### Problem

- 1 System was dropped or damaged.

### Action

 **CAUTION:** Only trained service technicians are authorized to remove the system cover and access any of the components inside the system. See your *Product Information Guide* for complete information about safety precautions, working inside the computer, and protecting against electrostatic discharge.

1. Open the system. See "[Opening the System](#)."
  2. Ensure that the following components are properly installed:
    - 1 Expansion-card cage
    - 1 Expansion cards
    - 1 Memory modules
    - 1 Processor(s)
    - 1 Power supplies
    - 1 Fans
    - 1 Hard drives
  3. Ensure that all cables are properly connected.
  4. Close the system. See "[Closing the System](#)."
  5. Run the system board tests in the system diagnostics. See "[Running the System Diagnostics](#)."  
If the tests fail, see "[Getting Help](#)."
- 

## Troubleshooting the System Battery

### Problem

- 1 System message indicates a problem with the battery.
- 1 System Setup program loses system configuration information.
- 1 System date and time do not remain current.

 **NOTE:** If the system is turned off for long periods of time (for weeks or months), the NVRAM may lose its system configuration information. This situation is caused by a defective battery.

### Action

1. Re-enter the time and date through the System Setup program. See "Using the System Setup Program" in your *User's Guide*.
2. Turn off the system and disconnect it from the electrical outlet for at least one hour.
3. Reconnect the system to the electrical outlet and turn on the system.
4. Enter the System Setup program.

If the date and time are not correct in the System Setup program, replace the battery. See "[System Battery](#)" in "Installing System Components."

If the problem is not resolved by replacing the battery, see "[Getting Help](#)."

 **NOTE:** Some software may cause the system time to speed up or slow down. If the system seems to operate normally except for the time kept in the System Setup program, the problem may be caused by software rather than by a defective battery.

---

## Troubleshooting Redundant Power Supplies

### Problem

- 1 System status indicator is amber.
- 1 Power supply fault indicator is amber.

### Action

1. Run the appropriate online diagnostics test. See "[Using Server Administrator Diagnostics](#)" in "Running the System Diagnostics."
2. Identify the faulty power supply.

The power supply's fault indicator is lit. See "[Power Indicator Codes](#)" in "Indicators, Messages, and Codes."

 **NOTICE:** The power supplies are hot-pluggable. Remove and install only one power supply at a time in a system that is powered on. The system is in the redundant mode when two power supplies are installed and both power supplies are connected to an AC power source. Operating the system with only one power supply installed and without a power supply blank installed for extended periods of time can cause the system to overheat.

3. Ensure that the power supply is properly installed by removing and reinstalling it. See "[Power Supplies](#)" in "Installing System Components."

 **NOTE:** After installing a power supply, allow several seconds for the system to recognize the power supply and to determine if it is working properly. The power indicator turns green to signify that the power supply is functioning properly. See "[Power Indicator Codes](#)" in "Indicators, Messages, and Codes."

If the problem persists, remove the faulty power supply. See "[Removing a Power Supply](#)" in "Installing System Components."

4. Install a new power supply. See "[Installing a Power Supply](#)" in "Installing System Components."

If the problem persists, see "[Getting Help](#)."

---

## Troubleshooting System Cooling Problems

### Problem

- 1 System status indicator is amber.
- 1 Systems management software issues a fan-related error message.

#### Action

 **CAUTION:** Only trained service technicians are authorized to remove the system cover and access any of the components inside the system. See your *Product Information Guide* for complete information about safety precautions, working inside the computer, and protecting against electrostatic discharge.

1. Run the appropriate diagnostic test. See "[Using Server Administrator Diagnostics](#)" in Running System Diagnostics."
  2. Open the system. See "[Opening the System](#)."
  3. Locate the fan referenced by the systems management software or diagnostics.  
See [Figure A-3](#) for the relative location of each fan.
  4. Ensure that the faulty fan is firmly seated in the fan bracket, to ensure contact with the fan power connector on the system board.
  5. Check that cables are not blocking the airflow within the system.
  6. Close the system. See "[Closing the System](#)."
  7. Reconnect the system to the electrical outlet, and turn on the system and attached peripherals.
  8. If the problem is not resolved, install a new fan. See "[Fans](#)" in "Installing System Components."
  9. If the replacement fan does not operate, see "[Getting Help](#)."
- 

## Troubleshooting System Memory

#### Problem

- 1 Faulty memory module.
- 1 Faulty system board.
- 1 System status indicator is amber.
- 1 LCD error code or system beep code indicates a memory problem.
- 1 Systems management software issues a memory-related message through the LCD display or systems management software.

#### Action

##### *Memory-related beep code during system startup.*

 **CAUTION:** Only trained service technicians are authorized to remove the system cover and access any of the components inside the system. See your *Product Information Guide* for complete information about safety precautions, working inside the computer, and protecting against electrostatic discharge.

1. Turn off the system and attached peripherals, and disconnect the system from the electrical outlet.
2. Open the system. See "[Opening the System](#)."
3. Reseat the memory modules in their sockets. See "[Installing Memory Modules](#)" in "Installing System Components."
4. Close the system. See "[Closing the System](#)."
5. Reconnect the system to the electrical outlet, and turn on the system and attached peripherals.

If there is no memory-related beep code, the problem is resolved.

6. Turn off the system and attached peripherals, and disconnect the system from the electrical outlet.
  - a. Open the system. See "[Opening the System](#)."
  - b. Remove all memory modules from the system. See "[Removing Memory Modules](#)" in "Installing System Components."
  - c. Replace one of the memory modules in socket DIMM1\_B.
  - d. Close the system. See "[Closing the System](#)."
  - e. Reconnect the system to the electrical outlet, and turn on the system and attached peripherals.
  - f. If there is no memory-related beep code, the memory module is not faulty.

If the beep code reoccurs, the memory module is faulty and should be replaced.
7. Perform the following steps:
  - a. Turn off the system and attached peripherals, and disconnect the system from its electrical outlet.
  - b. Open the system. See "[Opening the System](#)."
  - c. Repeat [step c](#) through [step f](#) in [step 6](#) for each memory module installed.
8. If you have tested all the memory modules and the problem persists, or none of the memory modules passes, the system board is faulty. See "[Getting Help](#)."

***The system starts up successfully but there are memory-related error messages.***

**⚠ CAUTION:** Only trained service technicians are authorized to remove the system cover and access any of the components inside the system. See your *Product Information Guide* for complete information about safety precautions, working inside the computer, and protecting against electrostatic discharge.

1. Turn off the system and attached peripherals, and disconnect the system from the electrical outlet.
2. Open the system. See "[Opening the System](#)."
3. Ensure that the memory modules are populated correctly. See "[General Memory Module Installation Guidelines](#)" in "Installing System Components."

If the memory modules are populated correctly, continue to the next step.
4. Reseat the memory modules in their sockets. See "[Installing Memory Modules](#)" in "Installing System Components."
5. Close the system. See "[Closing the System](#)."
6. Reconnect the system to the electrical outlet, and turn on the system and attached peripherals.

If there is no memory-related error message, the problem is resolved.

If the problem persists, see "[Getting Help](#)."

***There are memory-related error messages on the system LCD, or in the SEL.***

1. Enter the System Setup program and disable the **Redundant Memory** option, if applicable. See "Using the System Setup Program" in your *User's Guide*.
2. Run the appropriate online diagnostic test. See "[Using Server Administrator Diagnostics](#)" in "Running System Diagnostics."
3. Replace the memory module(s) identified by the diagnostics. See "[Installing Memory Modules](#)" in "Installing System Components."
4. Enter the System Setup program and enable the **Redundant Memory** option, if disabled in [step 1](#).
5. Restart the system. If there are still memory-related errors on the system LCD, or in the SEL, see "[Getting Help](#)."

---

## Troubleshooting a Diskette Drive

### Problem

- 1 Error message indicates a problem with the optional diskette drive.

## Action

 **CAUTION:** Only trained service technicians are authorized to remove the system cover and access any of the components inside the system. See your *Product Information Guide* for complete information about safety precautions, working inside the computer, and protecting against electrostatic discharge.

1. Enter the System Setup program and verify that the diskette controller is enabled and the diskette drive is configured correctly. See "Using the System Setup Program" in the *User's Guide*.
2. Run the appropriate online diagnostic test. See "[Using Server Administrator Diagnostics](#)" in "Running System Diagnostics."
3. Turn off the system and attached peripherals, and disconnect the system from the electrical outlet.
4. Ensure that the diskette/optical drive carrier is fully inserted in the system chassis. See [Figure 7-3](#).
5. Reconnect the system to the electrical outlet, and turn on the system and attached peripherals.
6. Run the appropriate online diagnostic test to see whether the diskette drive works correctly.
7. Turn off the system and attached peripherals, and disconnect the system from its electrical outlet.
8. Open the system. See "[Opening the System](#)."
9. Remove all expansion cards installed in the system. See "[Removing an Expansion Card](#)" in "Installing System Components."
10. Close the system. See "[Closing the System](#)."
11. Reconnect the system to the electrical outlet, and turn on the system and attached peripherals.
12. Run the appropriate online diagnostic test to see whether the diskette drive works correctly.  
  
If the tests run successfully, an expansion card may be conflicting with the diskette drive logic, or an expansion card may be faulty. Continue to the next step.  
  
If the tests fail, see "[Getting Help](#)."
13. Turn off the system and attached peripherals, and disconnect the system from the electrical outlet.
14. Open the system. See "[Opening the System](#)."
15. Reinstall one of the expansion cards you removed in [step 9](#). See "[Installing an Expansion Card](#)" in "Installing System Components."
16. Close the system. See "[Closing the System](#)."
17. Reconnect the system to the electrical outlet, and turn on the system and attached peripherals.
18. Run the appropriate online diagnostic test to see whether the diskette drive works correctly.
19. Repeat [step 13](#) through [step 18](#) until all expansion cards are reinstalled or one of the expansion cards causes the tests to fail.  
  
If the problem is not resolved, see "[Getting Help](#)."

---

## Troubleshooting an Optical Drive

### Problem

- 1 System cannot read data from a CD.
- 1 Optical drive indicator does not blink during boot.

### Action

**⚠ CAUTION:** Only trained service technicians are authorized to remove the system cover and access any of the components inside the system. See your *Product Information Guide* for complete information about safety precautions, working inside the computer, and protecting against electrostatic discharge.

1. Try using a different CD that you know works properly.
2. Enter the System Setup program and ensure that the drive's IDE controller is enabled. See "Using the System Setup Program" in the *User's Guide*.
3. Run the appropriate online diagnostic test. See "[Using Server Administrator Diagnostics](#)" in "Running System Diagnostics."
4. Turn off the system and attached peripherals, and disconnect the system from the electrical outlet.
5. Remove and reinstall the diskette/optical drive carrier, making sure it is fully inserted in the system chassis. See [Figure 7-3](#).
6. Reconnect the system to the electrical outlet, and turn on the system and attached peripherals.

If the problem is not resolved, see "[Getting Help](#)."

---

## Troubleshooting a SCSI Tape Drive

### Problem

1. Defective tape drive.
1. Defective tape cartridge.
1. Missing or corrupted tape-backup software or tape drive device driver.
1. Defective optional SCSI controller card.

### Action

**⚠ CAUTION:** Only trained service technicians are authorized to remove the system cover and access any of the components inside the system. See your *Product Information Guide* for complete information about safety precautions, working inside the computer, and protecting against electrostatic discharge.

1. Run the System Setup program and ensure that the secondary SCSI channel is enabled and set to SCSI.  
See "Using the System Setup Program" in the *User's Guide*.
2. Remove the tape cartridge you were using when the problem occurred, and replace it with a tape cartridge that you know works.
3. Ensure that the SCSI device drivers for the tape drive are installed and are configured correctly.
4. Reinstall the tape-backup software as instructed in the tape-backup software documentation.
5. Ensure that the tape drive's interface cable is connected to the tape drive and SCSI controller card, or the external SCSI connector on the system back panel. See [Figure 2-2](#).
6. Verify that the tape drive is configured for a unique SCSI ID number and that the tape drive is terminated or not terminated, based on the interface cable used to connect the drive.  
See the documentation for the tape drive for instructions on selecting the SCSI ID number and enabling or disabling termination.
7. Run the appropriate online diagnostics tests. See "[Using Server Administrator Diagnostics](#)" in "Running System Diagnostics."
8. Turn off the system and attached peripherals, and disconnect the system from the electrical outlet.
9. Open the system. See "[Opening the System](#)."
10. If the drive is connected to an optional SCSI controller card, check that the card is firmly seated in its connector. See "[Installing an Expansion Card](#)" in "Installing System Components."
11. If the drive is connected to the integrated SCSI controller on the riser card using the optional external SCSI connector on the system back panel, check the cable connection to the riser card.



12. Close the system. See "[Closing the System.](#)"
  13. Reconnect the system to the electrical outlet, and turn on the system, including attached peripherals.
  14. If the problem is not resolved, see the documentation for the tape drive for additional troubleshooting instructions.
  15. If you cannot resolve the problem, see "[Getting Help](#)" for information on obtaining technical assistance.
- 

## Troubleshooting SCSI Hard Drives

### Problem

- 1 Device driver error.
- 1 Hard drive not recognized by the system.

### Action

 **CAUTION:** Only trained service technicians are authorized to remove the system cover and access any of the components inside the system. See your *Product Information Guide* for complete information about safety precautions, working inside the computer, and protecting against electrostatic discharge.

 **NOTICE:** This procedure can destroy data stored on the hard drive. Before you continue, back up all files on the hard drive.

1. Run the appropriate online diagnostic test. See "[Using Server Administrator Diagnostics](#)" in "Running System Diagnostics."

For information about testing the controller, see the SCSI or RAID controller's documentation.

If the tests fail, continue to the next step.

2. Run the System Setup program and ensure that the SCSI controller is enabled.

See "Using the System Setup Program" in the *User's Guide*.

3. If the integrated SCSI host adapter controls the SCSI hard drives, restart the system and press <Ctrl><a> to enter the SCSI configuration utility program.

 **NOTE:** If your system has an optional RAID controller card or RAID on motherboard (ROMB) is enabled, restart the system and press <Ctrl><a> or <Ctrl><m>, depending on the utility. See the documentation supplied with the controller for information about the configuration utility.

4. Ensure that the primary SCSI channel is enabled, and restart the system.

See the documentation supplied with the controller for information about the configuration utility.

5. Verify that the device drivers are installed and configured correctly. See the operating system documentation.

6. Remove the hard drive and install it in another drive bay.

7. If the problem is resolved, reinstall the hard drive in the original bay. See "[Installing a SCSI Hard Drive](#)" in "Installing Drives."

If the hard drive functions properly in the original bay, the drive carrier could have intermittent problems. Replace the drive carrier. See "[Getting Help](#)."

If the problem persists, the SCSI backplane board has a defective connector. See "[Getting Help](#)."

8. Check the SCSI cable connections inside the system:

- a. Turn off the system, including any attached peripherals, and disconnect the system from the electrical outlet.
- b. Open the system. See "[Opening the System.](#)"
- c. Verify that the SCSI cable is securely connected to the SCSI backplane, and to the SCSI host adapter on the riser card, or a SCSI host adapter card installed in an expansion slot.
- d. Close the system. See "[Closing the System.](#)"

9. Format and partition the hard drive. See the operating system documentation.

10. If possible, restore the files to the drive.

If the problem persists, see "[Getting Help](#)."

---

## Troubleshooting the Integrated RAID Controller

### Problem

- 1 Error message indicates a problem with the optional integrated RAID controller.

### Action

 **CAUTION:** Only trained service technicians are authorized to remove the system cover and access any of the components inside the system. See your *Product Information Guide* for complete information about safety precautions, working inside the computer, and protecting against electrostatic discharge.

1. Run the appropriate online diagnostic test. See "[Using Server Administrator Diagnostics](#)" in "Running System Diagnostics."
2. Enter the System Setup program and ensure that the **Embedded RAID Controller** option is set to **RAID Enabled**. See "Using the System Setup Program" in your *User's Guide*.
3. Ensure that the integrated RAID controller is configured properly. See the RAID controller's documentation for information about configuration settings.

If the problem is not resolved, continue to the next step.

4. Turn off the system and attached peripherals, and disconnect the system from its electrical outlet.
5. Open the system. See "[Opening the System](#)."
6. Ensure that the following RAID components are properly installed:
  - 1 Memory module
  - 1 RAID key
  - 1 Battery

See "[Activating the Optional Integrated RAID Controller](#)" in "Installing Drives."

7. Close the system. See "[Closing the System](#)."
8. Reconnect the system to its electrical outlet, and turn on the system and attached peripherals.

If the problem is not resolved, continue to the next step.
9. Turn off the system and attached peripherals, and disconnect the system from its electrical outlet.
10. Open the system. See "[Opening the System](#)."

 **CAUTION:** Replace the battery only with the same or equivalent type recommended by the manufacturer. Discard used batteries according to the manufacturer's instructions. See the *Product Information Guide* for more information.

11. Replace the RAID battery. See "[Activating the Optional Integrated RAID Controller](#)" in "Installing Drives."
12. Close the system. See "[Closing the System](#)."
13. Reconnect the system to its electrical outlet, and turn on the system and attached peripherals.

If the problem persists, see "[Getting Help](#)."

---

## Troubleshooting a RAID Controller Card

 **NOTE:** When troubleshooting a RAID controller card, also see the documentation for your operating system and the RAID controller.

## Problem

- 1 Error message indicates a RAID controller problem.
- 1 RAID controller performs incorrectly or not at all.

## Action

 **CAUTION:** Only trained service technicians are authorized to remove the system cover and access any of the components inside the system. See your *Product Information Guide* for complete information about safety precautions, working inside the computer, and protecting against electrostatic discharge.

1. Run the appropriate online diagnostic test. See "[Using Server Administrator Diagnostics](#)" in "Running the System Diagnostics."
2. Turn off the system and attached peripherals, and disconnect the system from the electrical outlet.
3. Open the system. See "[Opening the System](#)."
4. Ensure that the controller card is firmly seated in its connector. See "[Installing an Expansion Card](#)" in "Installing System Components."
5. Ensure that the appropriate cables are firmly connected to their corresponding connectors on the controller card and SCSI backplane.
6. Close the system. See "[Closing the System](#)."
7. Reconnect the system to the electrical outlet, and turn on the system and attached peripherals.  
If the problem persists, see the RAID controller's documentation for more information on troubleshooting.

---

## Troubleshooting Expansion Cards

 **NOTE:** When troubleshooting an expansion card, see the documentation for your operating system and the expansion card.

## Problem

- 1 Error message indicates a problem with an expansion card.
- 1 Expansion card performs incorrectly or not at all.

## Action

 **CAUTION:** Only trained service technicians are authorized to remove the system cover and access any of the components inside the system. See your *Product Information Guide* for complete information about safety precautions, working inside the computer, and protecting against electrostatic discharge.

1. Run the appropriate online diagnostic test. See "[Using Server Administrator Diagnostics](#)" in "Running System Diagnostics."
2. Turn off the system and attached peripherals, and disconnect the system from the electrical outlet.
3. Open the system. See "[Opening the System](#)."
4. Ensure that the expansion-card cage is securely installed. See "[Removing the Expansion-Card Cage](#)" in "Installing System Components."
5. Ensure that each expansion card is firmly seated in its connector. See "[Installing an Expansion Card](#)" in "Installing System Components."
6. Close the system. See "[Closing the System](#)."
7. Reconnect the system to the electrical outlet, and turn on the system and attached peripherals.  
If the problem persists, go to the next step.
8. Turn off the system and attached peripherals, and disconnect the system from the electrical outlet.
9. Open the system. See "[Opening the System](#)."

10. Remove all expansion cards installed in the system. See "[Removing an Expansion Card](#)" in "Installing System Components."
  11. Close the system. See "[Closing the System](#)."
  12. Reconnect the system to the electrical outlet, and turn on the system and attached peripherals.
  13. Run the appropriate online diagnostic test.  
If the tests fail, see "[Getting Help](#)."
  14. For each expansion card you removed in [step 10](#), perform the following steps:
    - a. Turn off the system and attached peripherals, and disconnect the system from the electrical outlet.
    - b. Open the system. See "[Opening the System](#)."
    - c. Reinstall one of the expansion cards. See "[Installing an Expansion Card](#)."
    - d. Close the system. See "[Closing the System](#)."
    - e. Run the appropriate diagnostic test.  
If the tests fail, see "[Getting Help](#)."
- 

## Troubleshooting the Microprocessors

### Problem

1. Error message indicates a processor problem.
1. A heat sink is not installed for each processor.

### Action

 **CAUTION:** Only trained service technicians are authorized to remove the system cover and access any of the components inside the system. See your *Product Information Guide* for complete information about safety precautions, working inside the computer, and protecting against electrostatic discharge.

1. Run the appropriate online diagnostics test. See "[Using Server Administrator Diagnostics](#)" in "Running the System Diagnostics."
2. Turn off the system and attached peripherals, and disconnect the system from the electrical outlet.
3. Open the system. See "[Opening the System](#)."
4. Remove the processor fan bracket from the system. See "[Removing the Center Fan Bracket](#)" in "Installing System Components."
5. Ensure that each processor and heat sink are properly installed. See "[Replacing a Processor](#)" in "Installing System Components."
6. Replace the processor fan bracket in the system. See "[Removing the Center Fan Bracket](#)" in "Installing System Components."
7. Close the system. See "[Closing the System](#)."
8. Reconnect the system to the electrical outlet, and turn on the system and attached peripherals.
9. Run the appropriate online diagnostic test.  
If the tests fail or the problem persists, continue to the next step.
10. Turn off the system and attached peripherals, and disconnect the system from the electrical outlet.
11. Open the system. See "[Opening the System](#)."
12. Remove the second processor, leaving only processor 1 installed. See "[Replacing a Processor](#)" in "Installing System Components."  
To locate the processors, see [Figure A-3](#).  
If only one processor is installed, see "[Getting Help](#)."

13. Close the system. See "[Closing the System.](#)"
14. Reconnect the system to the electrical outlet, and turn on the system and attached peripherals.
15. Run the appropriate online diagnostic test.  
If the tests complete successfully, go to [step 21](#).
16. Turn off the system and attached peripherals, and disconnect the system from the electrical outlet.
17. Open the system. See "[Opening the System.](#)"
18. Replace processor 1 with another processor of the same capacity. See "[Replacing a Processor](#)" in "Installing System Components."
19. Close the system. See "[Closing the System.](#)"
20. Run the appropriate online diagnostic test.  
If the tests complete successfully, replace processor 1. See "[Getting Help.](#)"
21. Turn off the system and attached peripherals, and disconnect the system from the electrical outlet.
22. Open the system. See "[Opening the System.](#)"
23. Reinstall the second processor that you removed in [step 12](#). See "[Replacing a Processor](#)" in "Installing System Components."
24. Close the system. See "[Closing the System.](#)"
25. Reconnect the system to the electrical outlet, and turn on the system and attached peripherals.  
If the problem persists, see "[Getting Help.](#)"

---

[Back to Contents Page](#)

## Installing System Components

### Dell™ PowerEdge™ 2800 Systems Installation and Troubleshooting Guide

- [System Board Components](#)
- [System Battery](#)
- [Fans](#)
- [Power Supplies](#)
- [Expansion Cards](#)
- [System Memory](#)
- [Processor](#)
- [Installing a RAC Card](#)

This section describes how to install the following system components:

- 1 System battery
- 1 Cooling fans
- 1 Power supplies
- 1 Expansion cards
- 1 Riser card
- 1 System memory
- 1 Processors
- 1 RAC card

For information on adding SCSI devices, other types of drives, or activating the optional integrated RAID controller, see "[Installing Drives.](#)"

---

## System Board Components

When installing and replacing system board components, use [Figure 6-1](#) to locate the components.

Figure 6-1. System Board Components and Connectors

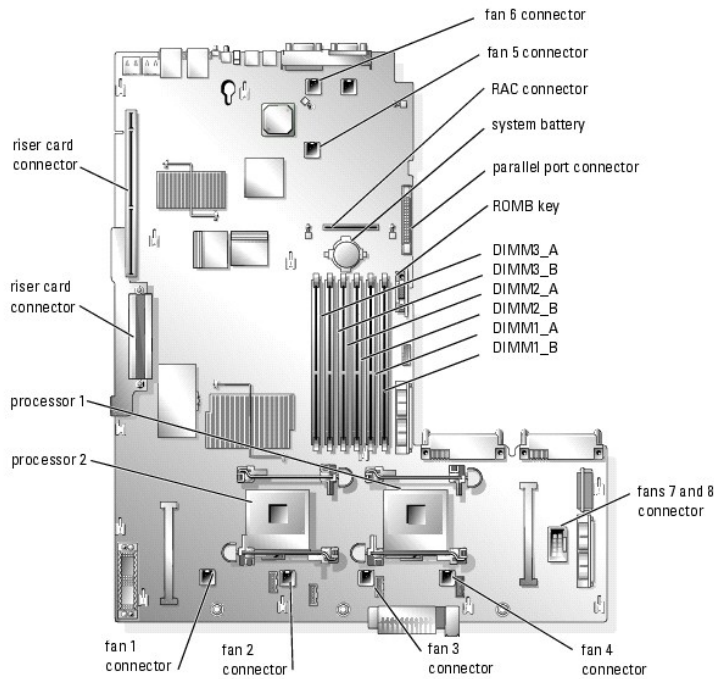

---

## System Battery

## Replacing the System Battery

**⚠ CAUTION:** Only trained service technicians are authorized to remove the system cover and access any of the components inside the system. See your *Product Information Guide* for complete information about safety precautions, working inside the computer, and protecting against electrostatic discharge.

1. Enter the System Setup program and record the option settings on the System Setup screens.

See "Using the System Setup Program" in the *User's Guide*.

2. Open the system. See "[Opening the System](#)" in "Troubleshooting Your System."
3. Remove the memory cooling shroud by lifting the release latch and sliding the shroud forward. See [Figure 6-16](#).
4. Remove the system battery. See [Figure A-3](#) for the battery connector location on the system board.

**➡ NOTICE:** To avoid damage to the battery connector, you must firmly support the connector while installing or removing a battery.

- a. Support the battery connector by pressing down firmly on the positive side of the connector. See [Figure 6-2](#).
- b. While supporting the battery connector, press the battery toward the positive side of the connector and pry it up out of the securing tabs at the negative side of the connector.

**Figure 6-2. Replacing the System Battery**

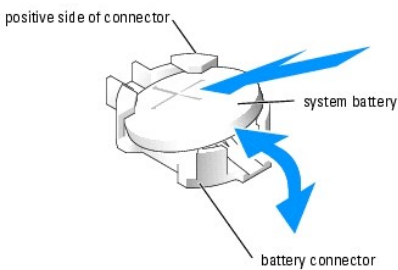

5. Install the new system battery with the side labeled "+" facing up. See [Figure 6-2](#).

**🔧 NOTE:** The side of the battery labeled "+" must face toward the open side of the battery socket.

6. Install the new system battery.
  - a. Support the battery connector by pressing down firmly on the positive side of the connector.
  - b. Hold the battery with the "+" facing up, and slide it under the securing tabs at the positive side of the connector.
  - c. Press the battery straight down into the connector until it snaps into place.
7. Replace the memory cooling shroud.
8. Close the system. See "[Closing the System](#)" in "Troubleshooting Your System."
9. Enter the System Setup program to confirm that the battery operates properly.
10. From the main screen, select **System Time** to enter the correct time and date.
11. Re-enter any system configuration information that is no longer displayed on the System Setup screens, and then exit the System Setup program.
12. To test the newly installed battery, see "[Troubleshooting the System Battery](#)" in "Troubleshooting Your System."

---

## Fans

The system's eight hot-plug fans provide cooling for the processors, memory modules, and expansion cards (see [Figure 6-3](#).)

- 1 Two processor cooling fans for each processor installed in the system (fans 1 through 4)
- 1 Two memory module cooling fans (fan 5 and fan 6)
- 1 Two expansion-card cooling fans (fan 7 and fan 8)

**NOTICE:** In the event of a problem with a particular fan, the fan's number is referenced by the system's management software, allowing you to easily identify and replace the proper fan.

Figure 6-3. Cooling Fans

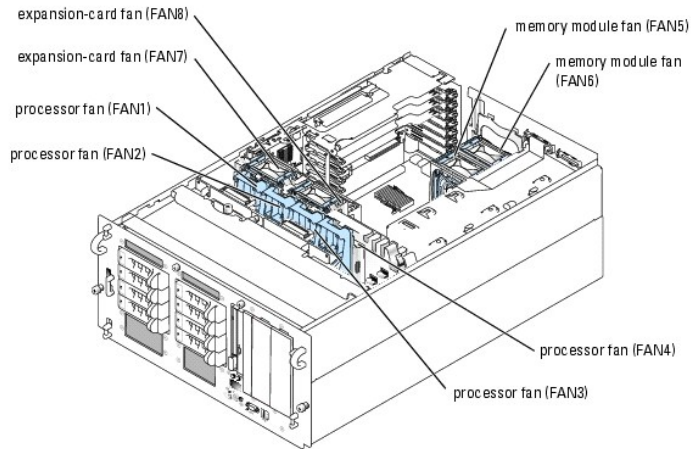

## Removing a Processor Fan

**CAUTION:** Only trained service technicians are authorized to remove the system cover and access any of the components inside the system. See your *Product Information Guide* for complete information about safety precautions, working inside the computer, and protecting against electrostatic discharge.

1. Open the system. See "[Opening the System](#)" in "Troubleshooting Your System."
2. Press the release tab on the fan carrier and lift the fan out of the center fan bracket. See [Figure 6-4](#).

Figure 6-4. Installing and Removing a Processor Fan

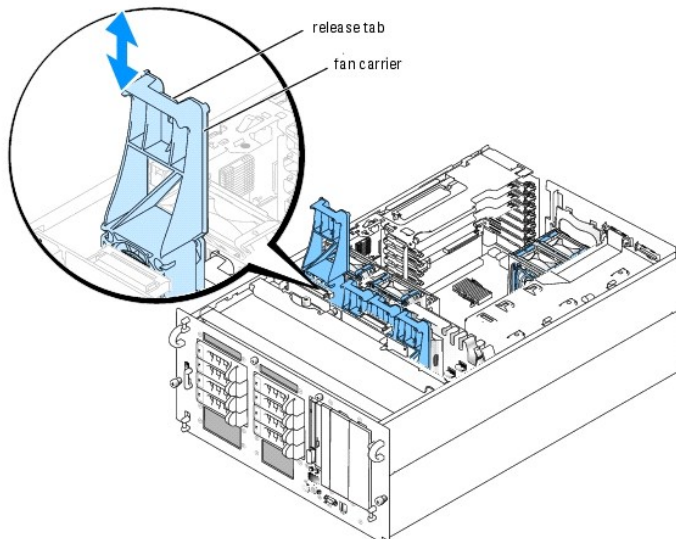



## Removing the Center Fan Bracket

**⚠ CAUTION:** Only trained service technicians are authorized to remove the system cover and access any of the components inside the system. See your *Product Information Guide* for complete information about safety precautions, working inside the computer, and protecting against electrostatic discharge.

1. Open the system. See "[Opening the System](#)" in "Troubleshooting Your System."
2. Remove the processor fans and expansion card fans. See "[Removing a Processor Fan](#)" and "[Removing an Expansion-Card Fan](#)."
3. Remove the expansion-card cage. See "[Removing the Expansion-Card Cage](#)."
4. Press the release tab on each end of the center fan bracket, then slide the bracket straight up and out of the system. See [Figure 6-5](#).

**🔧 NOTE:** When reinstalling the center fan bracket, ensure that the power connector on the bracket is aligned with the corresponding connector on the system board.

Figure 6-5. Installing and Removing the Center Fan Bracket

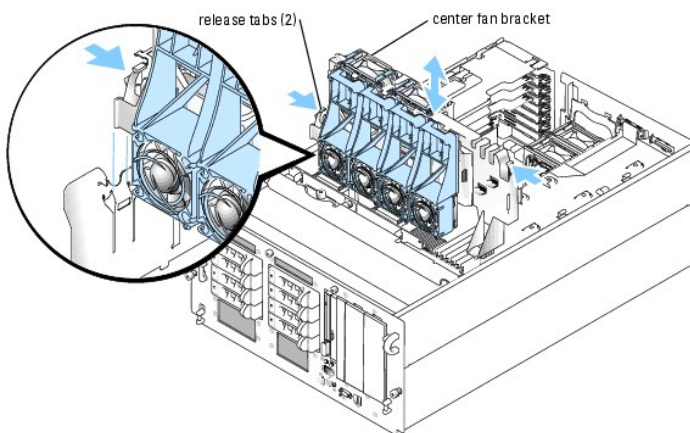

## Replacing the Center Fan Bracket

1. Slide the bracket into the system. Ensure that the power connector on the bracket is aligned with the corresponding connector on the system board.
2. Reinstall the expansion-card cage. See "[Installing the Expansion-Card Cage](#)."
3. Replace the processor fans and expansion-card fans.

## Removing a Memory Module Fan

**⚠ CAUTION:** Only trained service technicians are authorized to remove the system cover and access any of the components inside the system. See your *Product Information Guide* for complete information about safety precautions, working inside the computer, and protecting against electrostatic discharge.

1. Open the system. See "[Opening the System](#)" in "Troubleshooting Your System."
2. Compress the two latches on the top of the fan, then remove the fan. See [Figure 6-6](#).

Figure 6-6. Installing and Removing a Memory Module Fan

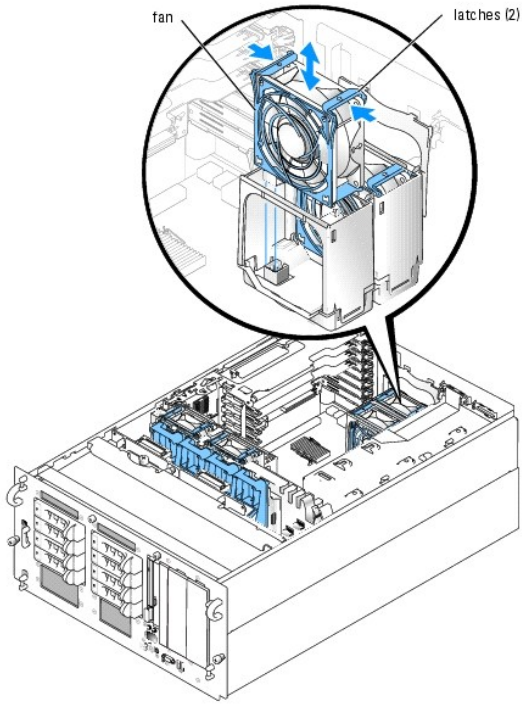

### Removing and Replacing the Back Fan Bracket

To remove the back fan bracket, pull the upper edge of the bracket away from the system back panel, then slide the bracket upwards. See [Figure 6-7](#).

Figure 6-7. Removing and Replacing the Back Fan Bracket

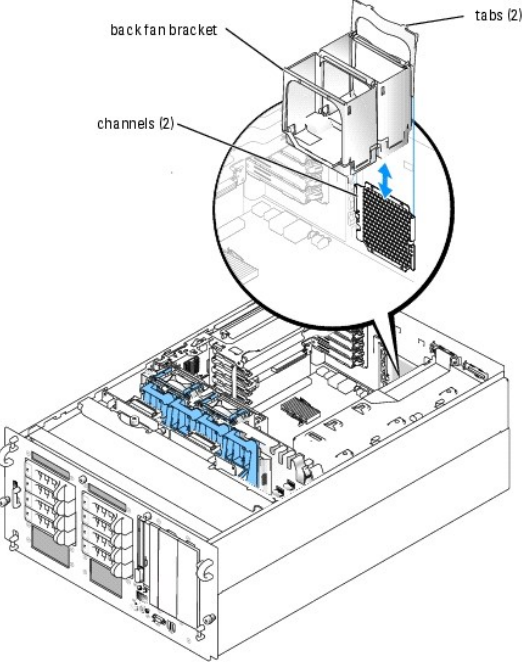

### Replacing the Back Fan Bracket

1. Slide the left and right edges of the bracket into the two corresponding channels on the inside of the system chassis back panel. See [Figure 6-7](#).
2. Lower the bracket into the system until the two tabs on the top edge of the bracket fit into the slots in the system back panel.

## Removing an Expansion-Card Fan

**⚠ CAUTION:** Only trained service technicians are authorized to remove the system cover and access any of the components inside the system. See your *Product Information Guide* for complete information about safety precautions, working inside the computer, and protecting against electrostatic discharge.

1. Open the system. See "[Opening the System](#)" in "Troubleshooting Your System."
2. Compress the two latches on the top of the fan, then remove the fan. See [Figure 6-8](#).

When installing the fan, ensure that the power connector on the fan is aligned with the connector on the center fan bracket. See [Figure 6-8](#).

Figure 6-8. Installing and Removing an Expansion-Card Fan

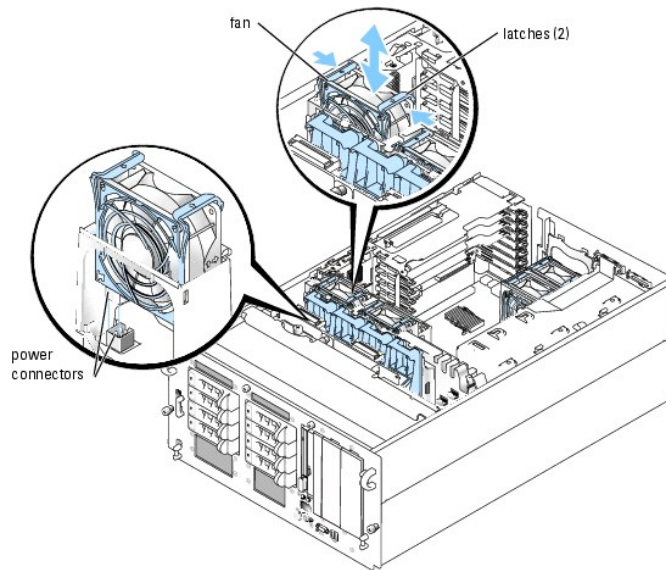

---

## Power Supplies

### Removing a Power Supply

➡ **NOTICE:** The system requires one power supply for the system to operate normally. The system is in the redundant mode when two power supplies are installed and both power supplies are connected to an AC power source. Remove and replace only one power supply at a time in a system that is powered on.

➡ **NOTICE:** If only one power supply is installed, it must be installed in the left power supply bay (1).

1. Disconnect the power cable from the power source.
2. Disconnect the power cable from the power supply.
3. Loosen the thumbscrew on the release lever, then open the lever and slide the power supply out of the chassis. See [Figure 6-9](#).

Figure 6-9. Installing and Removing a Power Supply

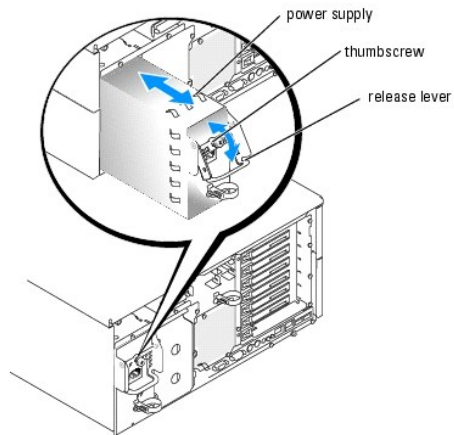

## Installing a Power Supply

1. If you are adding a second power supply, remove the power supply filler panel. See "[Removing the Power Supply Bay Filler Panel.](#)"
2. Holding the release lever in the open position, slide the new power supply into the chassis until the release lever contacts the system chassis. See [Figure 6-9.](#)
3. Close the release lever until the power supply is fully seated.
4. Lock the retention lever in place using the thumbscrew. See [Figure 6-9.](#)
5. Connect the power cable to the power supply and plug the cable into a power outlet.

**NOTICE:** When connecting the power cable, insert the cable through the strain-relief loop.

After installing a new power supply in a system with two power supplies, allow several seconds for the system to recognize the power supply and determine whether it is working properly. The power-on indicator will turn green to signify that the power supply is functioning properly (see [Figure 2-4](#)).

## Removing the Power Supply Bay Filler Panel

1. Grasp the filler panel using the two holes. See [Figure 6-10.](#)
2. Lift the panel upwards, then rotate the lower edge of the panel away from the system back panel. See [Figure 6-10.](#)

Figure 6-10. Removing the Power Supply Bay Filler Panel

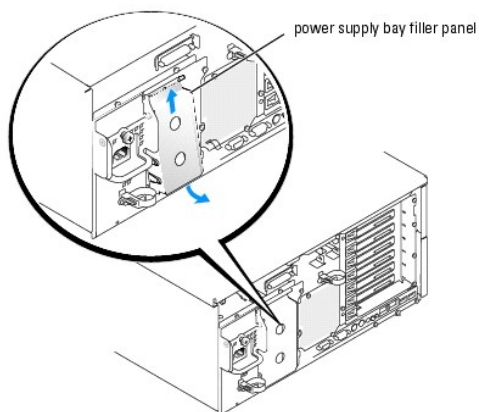

## Expansion Cards

Your system supports up to seven full-length expansion cards, installed in connectors on a riser card. The expansion slots are configured as follows:

- o Slot 1 is a 5-V, 32-bit, 33-MHz legacy PCI expansion slot.
- o Slots 2 through 5 are 3.3-V, 64-bit, 133-MHz PCI-X expansion slots.
- o Slot 6 is a hot-plug, x4 lane-width PCI-Express expansion slot.
- o Slot 7 is a hot-plug, x8 lane-width PCI-Express expansion slot.

[Figure 6-11](#) shows the relative locations of the expansion-card slots

**Figure 6-11. Expansion Slots**

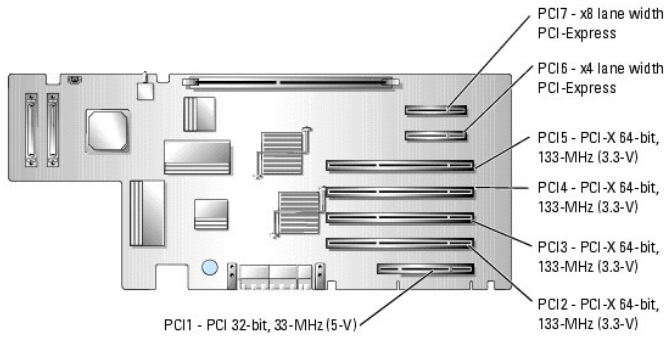

## Hot-Plug Expansion Cards

Your system supports PCI Express hot-plug expansion cards in slots 6 and 7. The indicators on each expansion slot insulator show the state of the expansion-card connector. See [Figure 6-11](#) and [Table 6-1](#).

- ➔ **NOTICE:** Your system's operating system and the expansion card itself must both support hot-plug installation and removal.
- ➔ **NOTICE:** To avoid damage to the expansion card or system board, refer to the expansion slot indicator when you add or remove a PCI-Express expansion card.

**Table 6-1. Hot-Plug Expansion Slot Indicators**

Green Power Indicator	Amber Attention Indicator	Safe to Add / Remove Card	Description
Off	Off	Yes	Connector power is off
On	Off	No	Connector power is on
Flash	Off	No	Connector is being powered up or powered down
Off	On	Yes	Fault
On	Flash	No	Slot is being identified

## Removing the Expansion-Card Cage

To install non-hot plug expansion cards or access certain system components such as the processors, you must remove the expansion-card cage.

- 🔧 **NOTE:** You should not remove the expansion-card cage in order to install or remove hot-plug expansion cards.
- ⚠️ **CAUTION:** Only trained service technicians are authorized to remove the system cover and access any of the components inside the system. See your *Product Information Guide* for complete information about safety precautions, working inside the computer, and protecting against electrostatic discharge.

1. Turn off the system and attached peripherals, and disconnect the system from the electrical outlet.
2. Open the system. See "[Opening the System](#)" in "Troubleshooting Your System."

- ➔ **NOTICE:** If two SCSI data cables are connected to the riser card, carefully note their relative locations so you can reinstall them correctly.

3. Disconnect the SCSI data cable(s) from the riser card.

If two SCSI cables are connected, note their relative locations.

4. Unlock the expansion-card cage cam lever and rotate it to the vertical position. See [Figure 6-12](#).
5. Lift the expansion-card cage from the chassis.

**Figure 6-12. Installing and Removing the Expansion-Card Cage**

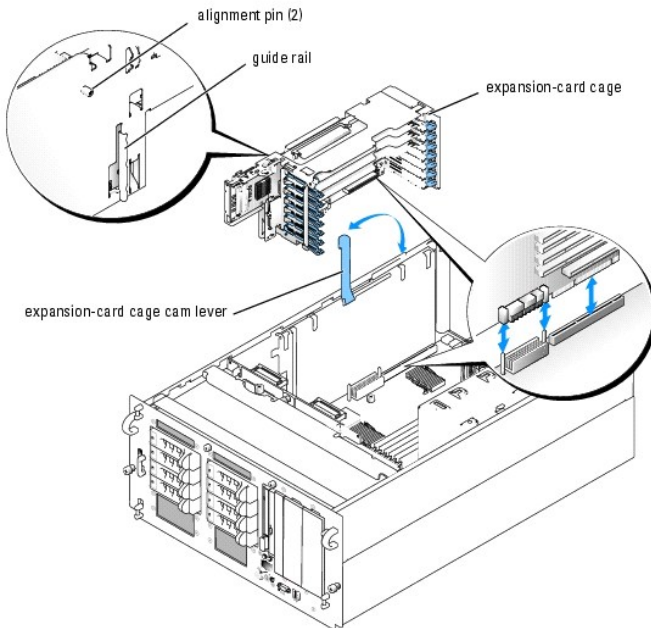

## Installing the Expansion-Card Cage

**CAUTION:** Only trained service technicians are authorized to remove the system cover and access any of the components inside the system. See your *Product Information Guide* for complete information about safety precautions, working inside the computer, and protecting against electrostatic discharge.

1. Reinstall any expansion card(s). See "[Installing an Expansion Card](#)."
2. Raise the expansion-card cage cam lever to a vertical position. See [Figure 6-12](#).
3. Fit the guide rail on the back of the expansion-card cage into the corresponding notch in the system chassis, then lower the expansion-card cage into the system chassis. See [Figure 6-12](#).
4. As you lower the cage into place, the two alignment pins fit into the slots in the side of the system.
5. Carefully close the cam lever to lock the card cage into place.

**NOTICE:** If two SCSI data cables were connected to the riser card or SCSI controller, reinstall them in the same relative locations.

6. Reconnect the SCSI data cable(s) to the SCSI connector(s) on the riser card or SCSI controller. See [Figure A-4](#).
7. Close the system. See "[Closing the System](#)" in "Troubleshooting Your System."

## Installing an Expansion Card

**CAUTION:** Only trained service technicians are authorized to remove the system cover and access any of the components inside the system. See your *Product Information Guide* for complete information about safety precautions, working inside the computer, and protecting against electrostatic discharge.

## Installing a Non-Hot-Plug Expansion Card

1. Turn off the system and attached peripherals, and disconnect the system from the electrical outlet.
2. Open the system. See "[Opening the System](#)" in "Troubleshooting Your System."
3. Remove the expansion-card cage. See "[Removing the Expansion-Card Cage](#)."
4. Open the plastic expansion-card retainer adjacent to the back of the empty slot. See [Figure 6-13](#).

**Figure 6-13. Installing and Removing Non-Hot-Plug Expansion Cards**

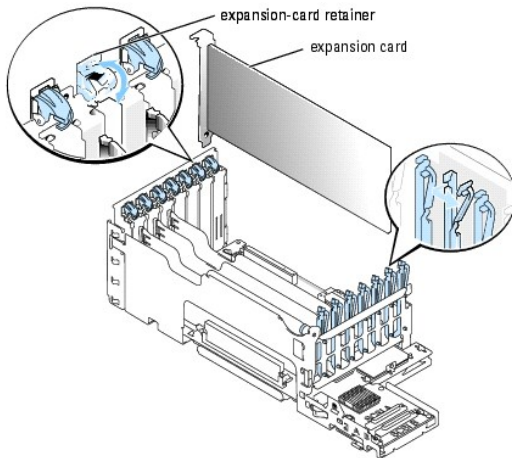

5. Remove the filler bracket on the slot you will be using.
  - NOTE:** Keep this bracket if you need to remove the expansion card. Filler brackets must be installed over empty expansion-card slots to maintain Federal Communications Commission (FCC) certification of the system. The brackets also keep dust and dirt out of the system and aid in proper cooling and airflow inside the system.
6. Insert the expansion card firmly into the expansion-card connector until the card is fully seated.
  - NOTE:** Ensure that the expansion-card bracket is also inserted into the securing slot on the back of the expansion-card cage.
7. Close the expansion-card retainer. See [Figure 6-13](#).
8. Reinstall the expansion-card cage. See "[Installing the Expansion-Card Cage](#)."
9. Connect any internal or external cable(s) to the expansion card.
10. Close the system. See "[Closing the System](#)" in "Troubleshooting Your System."

## Installing a Hot-Plug Expansion Card

- NOTE:** Your system's operating system and the expansion card itself must both support hot-plug installation and removal.

1. Open the system. See "[Opening the System](#)" in "Troubleshooting Your System."
2. To power down the expansion slot, press the indicator/switch at the end of the expansion slot. See [Figure 6-14](#).
3. Wait until the green and amber indicators for the slot are both off. See [Figure 6-14](#) and [Table 6-1](#).

**Figure 6-14. Installing and Removing Hot-Plug Expansion Cards**

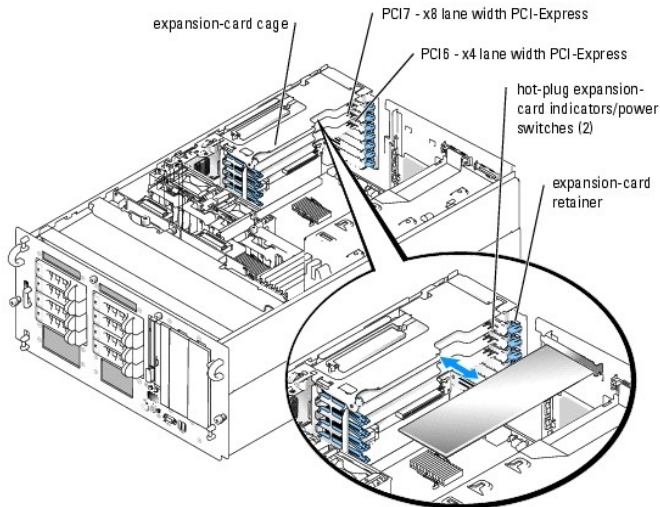

4. Open the plastic expansion-card retainer adjacent to the back of the empty slot. See [Figure 6-14](#).

5. Remove the filler bracket on the slot you will be using.

🔍 **NOTICE:** Be very careful when removing the bracket to avoid dropping it onto the system board and damaging the system board.

🔍 **NOTE:** Keep this bracket if you need to remove the expansion card. Filler brackets must be installed over empty expansion-card slots to maintain FCC certification of the system. The brackets also keep dust and dirt out of the system and aid in proper cooling and airflow inside the system.

6. Insert the expansion card firmly into the expansion-card connector until the card is fully seated, being careful not to remove the riser card from the system board. Ensure that the expansion-card bracket is also inserted into the securing slot on the chassis's back panel.

7. Close the expansion-card retainer.

8. Connect any internal or external cable(s) to the expansion card.

9. Power up the expansion slot.

10. Close the system. See "[Closing the System](#)" in "Troubleshooting Your System."

## Removing an Expansion Card

### Removing a Non-Hot Plug Expansion Card

⚠️ **CAUTION:** See your *Product Information Guide* for complete information about safety precautions, working inside the computer, and protecting against electrostatic discharge.

1. Turn off the system and attached peripherals, and disconnect the system from the electrical outlet.

2. Open the system. See "[Opening the System](#)" in "Troubleshooting Your System."

3. Disconnect any internal or external cable(s) that are connected to the expansion card.

4. Remove the expansion-card cage. See "[Removing the Expansion-Card Cage](#)."

5. Open the expansion-card retainer adjacent to the slot. See [Figure 6-13](#).

6. Grasp the expansion card and carefully remove it from the riser-card connector.

7. If you are permanently removing the card, replace the metal filler bracket over the empty card-slot opening.

🔍 **NOTE:** Filler brackets must be installed over empty expansion-card slots to maintain FCC certification of the system. The brackets also keep dust and dirt out of the system and aid in proper cooling and airflow inside the system.



8. Close the expansion-card retainer.
9. Reinstall the expansion-card cage. See "[Installing the Expansion-Card Cage](#)."
10. Close the system. See "[Closing the System](#)" in "Troubleshooting Your System."

## Removing a Hot-Plug Expansion Card

 **CAUTION:** See your *Product Information Guide* for complete information about safety precautions, working inside the computer, and protecting against electrostatic discharge.

1. Open the system. See "[Opening the System](#)" in "Troubleshooting Your System."
2. To power down the expansion slot, press the indicator/switch at the end of the expansion slot. See [Figure 6-14](#).
3. Wait until the green and amber indicators for the slot are both off. See [Figure 6-14](#) and [Table 6-1](#).
4. Disconnect any internal or external cable(s) that are connected to the expansion card.
5. Open the expansion-card retainer adjacent to the PCI slot.
6. Grasp the expansion card and carefully remove it from the riser-card connector.
7. If you are permanently removing the card, replace the metal filler bracket over the empty card-slot opening.

 **NOTE:** Filler brackets must be installed over empty expansion-card slots to maintain FCC certification of the system. The brackets also keep dust and dirt out of the system and aid in proper cooling and airflow inside the system.

8. Close the expansion-card retainer.
9. Close the system. See "[Closing the System](#)" in "Troubleshooting Your System."

---

## System Memory

You can upgrade your system memory to a maximum of 16 GB by installing combinations of 256-MB, 512-MB, 1-GB, 2-GB, or 4-GB (when available) 2-way registered ECC PC2-3200 (DDR II 400) memory. The memory sockets are located on the system board adjacent to the power supply bays. See [Figure 6-1](#).

 **NOTE:** Two-way interleaving is not supported in the 256-MB single memory module configuration.

 **NOTICE:** If you remove your original memory modules from the system during a memory upgrade, keep them separate from any new memory modules that you may have. Use only registered ECC PC2-3200 compliant (DDR II 400) memory modules.

The system memory is located on the system board adjacent to the power supply bays. See [Figure 6-1](#). The memory module sockets are arranged in three banks on two channels (A and B). The memory module banks are identified as follows:

- 1 Bank 1: DIMM1\_A and DIMM1\_B
- 1 Bank 2: DIMM2\_A and DIMM2\_B
- 1 Bank 3: DIMM3\_A and DIMM3\_B

## General Memory Module Installation Guidelines

- 1 If only one memory module is installed, it must be installed in socket DIMM1\_A or DIMM1\_B.
- 1 If two or more memory modules are installed, they must be installed in pairs of matched memory size, speed, and technology.
- 1 The system supports both single-ranked and dual-ranked memory modules.
- 1 If you install both single-ranked and dual-ranked memory modules, the dual-ranked memory modules must be installed in bank 1.
- 1 Dual-ranked memory modules are not supported in bank 3.
- 1 If dual-ranked memory modules are installed in bank 2, you cannot install any memory modules in bank 3.

Memory modules marked with a 1R are single ranked and modules marked with a 2R are dual ranked. See [Figure 6-15](#).

**Figure 6-15. Determining a Memory Module's Capacity and Rank**

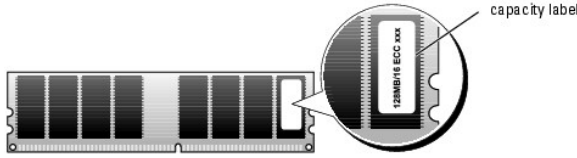

## Spare Bank Support

If six identical single-rank memory modules are installed, the memory modules in bank 3 (DIMM3\_A and DIMM3\_B) can function as a spare bank if you select the spare bank option using the System Setup program.

## Memory Mirroring Support

The system supports memory mirroring if identical memory modules are installed in bank 1 and bank 2, and no memory modules are installed in bank 3.

[Table 6-2](#) and [Table 6-3](#) show examples of different memory configurations. [Table 6-3](#) lists the various allowable combinations of single- and dual-ranked memory modules.

**Table 6-2. Sample Memory Configurations**

Total Memory	DIMM1_A	DIMM1_B	DIMM2_A	DIMM2_B	DIMM3_A	DIMM3_B
256 MB	256 MB	none	none	none	none	none
1 GB	256 MB	256 MB	256 MB	256 MB	none	none
1 GB	512 MB	512 MB	none	none	none	none
2 GB	512 MB	512 MB	512 MB	512 MB	none	none
2 GB	1 GB	1 GB	none	none	none	none
3 GB	1 GB	1 GB	512 MB	512 MB	none	none
3 GB	512 MB	512 MB	512 MB	512 MB	512 MB	512 MB
4 GB	1 GB	1 GB	1 GB	1 GB	none	none
4 GB	1 GB	1 GB	512 MB	512 MB	512 MB	512 MB
6 GB	2 GB	2 GB	1 GB	1 GB	none	none
6 GB	1 GB	1 GB	1 GB	1 GB	1 GB	1 GB
8 GB	2 GB	2 GB	2 GB	2 GB	none	none
8 GB	4 GB	4 GB	none	none	none	none
12 GB	2 GB	2 GB	2 GB	2 GB	2 GB	2 GB
16 GB	4 GB	4 GB	4 GB	4 GB	none	none

**Table 6-3. Allowable Memory Module Configurations – Single-Ranked and Dual-Ranked Memory Modules**

DIMM1_A	DIMM1_B	DIMM2_A	DIMM2_B	DIMM3_A	DIMM3_B
Single rank	none	none	none	none	none
Single rank	Single rank	none	none	none	none
Dual rank	Dual rank	none	none	none	none
Single rank	Single rank	Single rank	Single rank	none	none
Dual rank	Dual rank	Dual rank	Dual rank	none	none
Dual rank	Dual rank	Single rank	Single rank	none	none
Single rank	Single rank	Single rank	Single rank	Single rank	Single rank
Dual rank	Dual rank	Single rank	Single rank	Single rank	Single rank

## Installing Memory Modules

**CAUTION:** Only trained service technicians are authorized to remove the system cover and access any of the components inside the system. See your *Product Information Guide* for complete information about safety precautions, working inside the computer, and protecting against electrostatic discharge.

1. Open the system. See "[Opening the System](#)" in "Troubleshooting Your System."
2. To remove the memory cooling shroud, lift the release latch and slide the shroud forward. See [Figure 6-16](#).

**Figure 6-16. Removing the Memory Cooling Shroud**

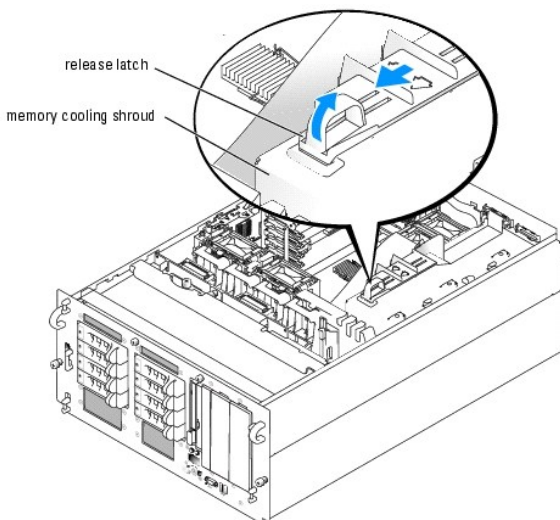

3. Locate the memory module sockets. See [Figure A-3](#).
4. Press the ejectors on the memory module socket down and out, as shown in [Figure 6-17](#), to allow the memory module to be inserted into the socket.

**Figure 6-17. Installing and Removing a Memory Module**

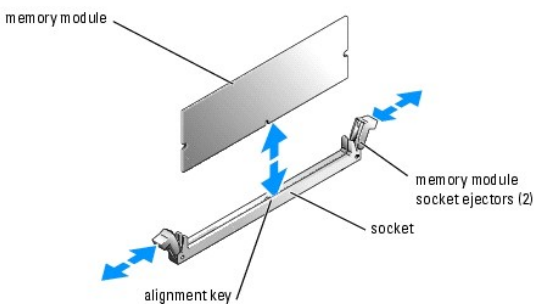

5. Align the memory module's edge connector with the alignment key on the memory module socket, and insert the memory module in the socket.
 

**NOTE:** The memory module socket has an alignment key that allows you to install the memory module in the socket in only one way.
6. Press down on the memory module with your thumbs while pulling up on the ejectors with your index fingers to lock the memory module into the socket.
 

When the memory module is properly seated in the socket, the ejectors on the memory module socket align with the ejectors on the other sockets that have memory modules installed.
7. Repeat [step 3](#) through [step 6](#) of this procedure to install the remaining memory modules. See [Table 6-2](#) and [Table 6-3](#) for sample memory configurations.
8. Replace the memory cooling shroud.
9. Close the system. See "[Closing the System](#)" in "Troubleshooting Your System."
10. (Optional) Press <F2> to enter the System Setup program, and check the **System Memory** setting on the main **System Setup** screen.
 

The system should have already changed the value to reflect the newly installed memory.

11. If the value is incorrect, one or more of the memory modules may not be installed properly. Repeat [step 1](#) through [step 10](#) of this procedure, checking to ensure that the memory modules are firmly seated in their sockets.
12. Run the system memory test in the system diagnostics. See "[Running the System Diagnostics](#)."

## Removing Memory Modules

**⚠ CAUTION:** Only trained service technicians are authorized to remove the system cover and access any of the components inside the system. See your *Product Information Guide* for complete information about safety precautions, working inside the computer, and protecting against electrostatic discharge.

1. Open the system. See "[Opening the System](#)" in "Troubleshooting Your System."
  2. Locate the memory module sockets. See [Figure 6-1](#).
  3. Press down and out on the ejectors on each end of the socket until the memory module pops out of the socket. See [Figure 6-17](#).
  4. Close the system. See "[Closing the System](#)" in "Troubleshooting Your System."
- 

## Processor

You can upgrade the system processor(s) to take advantage of future options in speed and functionality, or add a second processor. Each processor and its associated internal cache memory are contained in a pin grid array (PGA) package that is installed in a ZIF socket on the system board.

The following items are included in the processor upgrade kit:

- 1 Processor
- 1 Heat sink
- 1 Two processor cooling fans (if you are adding a second processor)

## Replacing a Processor

**⚠ CAUTION:** Only trained service technicians are authorized to remove the system cover and access any of the components inside the system. See your *Product Information Guide* for complete information about safety precautions, working inside the computer, and protecting against electrostatic discharge.

1. Open the system. See "[Opening the System](#)" in "Troubleshooting Your System."
2. Remove the center fan bracket. See "[Removing the Center Fan Bracket](#)."

**➡ NOTICE:** When you remove the heat sink, the possibility exists that the processor might adhere to the heat sink and be removed from the socket. It is recommended that you remove the heat sink while the processor is still warm.

**➡ NOTICE:** Never remove the heat sink from a processor unless you intend to remove the processor. The heat sink is necessary to maintain proper thermal conditions.

3. Press the blue tab on the end of one of the heat-sink retention levers to disengage the lever, then lift the lever 90 degrees. See [Figure 6-18](#).

**Figure 6-18. Installing and Removing the Heat Sink**

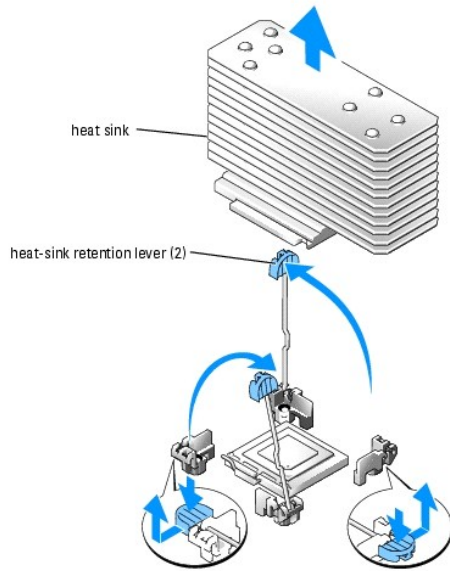

4. Wait 30 seconds for the heat sink to loosen from the processor.
5. Open the other heat sink retention lever.
6. If the heat sink has not separated from the processor, carefully rotate the heat sink in a clockwise, then counterclockwise, direction until it releases from the processor. Do not pry the heat sink off of the processor.
7. Lift the heat sink off of the processor and set the heat sink upside down so as not to contaminate the thermal grease.
8. Pull the socket-release lever straight up until the processor is released from the socket. See [Figure 6-19](#).

**Figure 6-19. Installing and Removing a Processor**

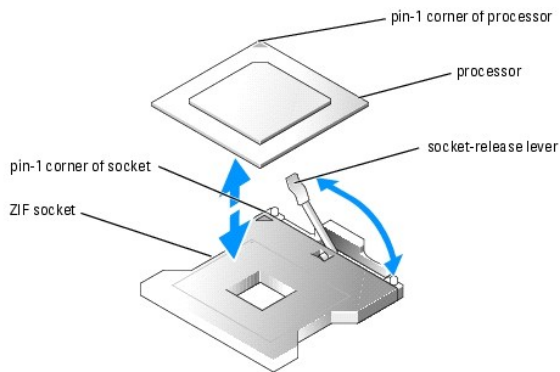

9. Lift the processor out of the socket and leave the release lever up so that the socket is ready for the new processor.

**NOTICE:** Be careful not to bend any of the pins when removing the processor. Bending the pins can permanently damage the processor.

10. Unpack the new processor.

If any of the pins on the processor appear bent, see ["Getting Help."](#)

11. Align the pin-1 corner of the processor with the pin-1 corner of the ZIF socket. See [Figure 6-19](#).

**NOTE:** Identifying the pin-1 corners is critical to positioning the processor correctly.

Identify the pin-1 corner of the processor by locating the tiny gold triangle on one corner of the processor. Place this corner in the same corner of the ZIF

socket identified by a corresponding triangle.

12. Install the processor in the socket.

 **NOTICE:** Positioning the processor incorrectly can permanently damage the processor and the system when you turn it on. When placing the processor in the socket, be sure that all of the pins on the processor enter the corresponding holes. Be careful not to bend the pins.

- a. If the release lever on the processor socket is not positioned all the way up, move it to that position.
- b. With the pin-1 corners of the processor and socket aligned, set the processor lightly in the socket, making sure all pins are matched with the correct holes in the socket.

Because the system uses a ZIF processor socket, do not use force, which could bend the pins if the processor is misaligned.

When the processor is positioned correctly, it drops down into the socket with minimal pressure.

- c. When the processor is fully seated in the socket, rotate the socket release lever back down until it snaps into place, securing the processor.
13. Install the heat sink.
    - a. Using a clean lint-free cloth, remove the existing thermal grease from the heat sink.

 **NOTE:** Use the heat sink that you removed in [step 7](#).

- b. Apply thermal grease evenly to the top of the processor.
- c. Place the heat sink onto the processor. See [Figure 6-18](#).
- d. Close one of the two heat sink retention levers until it locks. See [Figure 6-18](#).
- e. Repeat for the other heat sink retention lever.

14. Reinstall the center fan bracket. See "[Replacing the Center Fan Bracket](#)."

15. If you have added a second processor, install the two processor cooling fans for the new processor. See "[Installing and Removing a Processor Fan](#)."

16. Close the system. See "[Closing the System](#)" in "Troubleshooting Your System."

As the system boots, it detects the presence of the new processor and automatically changes the system configuration information in the System Setup program.

17. Press <F2> to enter the System Setup program, and check that the processor information matches the new system configuration.

See your *User's Guide* for instructions about using the System Setup program.

18. Run the system diagnostics to verify that the new processor operates correctly.

See "[Running the System Diagnostics](#)" for information about running the diagnostics and troubleshooting processor problems.

---

## Installing a RAC Card

 **CAUTION:** Only trained service technicians are authorized to remove the system cover and access any of the components inside the system. See your *Product Information Guide* for complete information about safety precautions, working inside the computer, and protecting against electrostatic discharge.

1. Turn off the system, including any attached peripherals, and disconnect the system from the electrical outlet.
2. Open the system. See "[Opening the System](#)" in "Troubleshooting Your System."
3. Remove the memory cooling shroud by lifting the release latch and sliding the shroud forward. See [Figure 6-16](#).
4. Remove the two memory module fans at the back of the system. See "[Removing a Memory Module Fan](#)."
5. Remove the back fan bracket. See "[Removing and Replacing the Back Fan Bracket](#)."
6. Remove the filler plug from the system back panel. See [Figure 6-20](#).

**Figure 6-20. Installing a RAC Card**

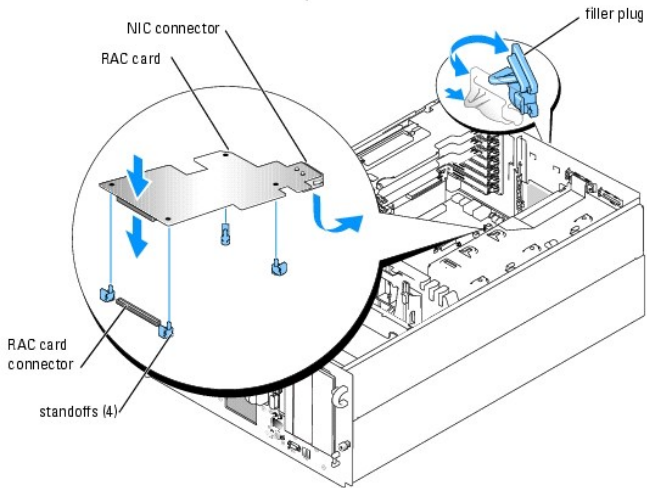

7. Angle the RAC card so that its NIC connector inserts through the back-panel RAC card opening, and then straighten the card. See [Figure 6-20](#).
  8. Install the card:
    - a. Hold the card by its edges with the holes in the corners of the card aligned with the four plastic standoffs on the system board. See [Figure 6-20](#).
    - b. Carefully press the left end of the card onto the RAC card connector on the system board, until the clips on the plastic standoffs snap over that end of the card. See [Figure 6-20](#).
    - c. Press down on the other end of the card until the remaining two standoffs fit over the card edge.
  9. Reinstall the back fan bracket. See "[Removing and Replacing the Back Fan Bracket](#)."
  10. Reinstall the two memory module fans.
  11. Reinstall the memory cooling shroud.
  12. Close the system. See "[Closing the System](#)" in "Troubleshooting Your System."
  13. Reconnect the system and peripherals to their power sources, and turn them on.
  14. Enter the System Setup program and verify that the setting for the RAC card has changed to reflect the presence of the card. See "Using the System Setup Program" in your *User's Guide*.
- See the RAC card documentation for information on configuring and using the RAC card.

---

[Back to Contents Page](#)

## Installing Drives

### Dell™ PowerEdge™ 2800 Systems Installation and Troubleshooting Guide

- [Installing SCSI Hard Drives](#)
- [Installing a Diskette Drive](#)
- [Removing the Peripheral Bay Filler Panel \(Tower Systems Only\)](#)
- [Installing an Optical Drive](#)
- [Installing an Internal SCSI Tape Drive](#)
- [Connecting an External SCSI Tape Drive](#)
- [Configuring the Boot Drive](#)
- [Activating the Optional Integrated RAID Controller](#)
- [Installing a RAID Controller Card](#)
- [SCSI Hard-Drive Cabling Guidelines](#)

Your system features eight standard internal hard-drive bays that accommodate up to eight SCSI hard drives. Systems with an optional RAID controller card or optional ROMB support hot-plug SCSI drive operation.

The system's two peripheral bays can accommodate up to two 5-1/4-inch form-factor devices (such as tape drives) or an optional 1x2 SCSI backplane to enable installation of two additional SCSI hard drives.

---

## Installing SCSI Hard Drives

[Figure 7-1](#) shows the SCSI ID numbers of the eight standard drive bays. (SCSI ID 6 and SCSI ID 7 are reserved for use by the system's integrated SCSI host adapter and SCSI enclosure management controller.)

Figure 7-1. Hard-Drive SCSI ID Numbers

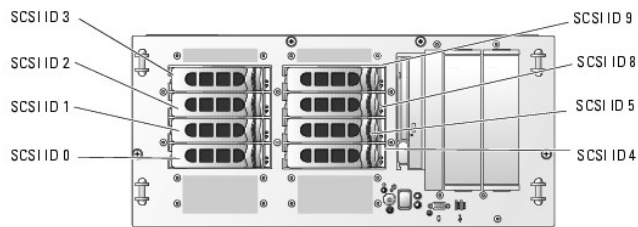

### Before You Begin

SCSI hard drives are supplied in special drive carriers that fit in the hard-drive bays.

- ➔ **NOTICE:** Before attempting to remove or install a drive while the system is running, see the documentation for the optional RAID controller card or optional ROMB to ensure that the host adapter is configured correctly to support hot-plug drive removal and insertion.
- 📌 **NOTE:** It is recommended that you use only drives that have been tested and approved for use with the SCSI backplane board.

You may need to use different programs than those provided with the operating system to partition and format SCSI hard drives.

- ➔ **NOTICE:** Do not turn off or reboot your system while the drive is being formatted. Doing so can cause a drive failure.

When you format a high-capacity SCSI hard drive, allow enough time for the formatting to be completed. Long format times for these drives are normal. A 9-GB hard drive, for example, can take up to 2.5 hours to format.

### Installing a SCSI Hard Drive

- ➔ **NOTICE:** Hot-plug drive installation is not supported for systems without an optional RAID controller card or optional ROMB.

1. If the system does not have an optional RAID controller card or optional riser card with ROMB, shut down the system.
2. Remove the front bezel, if attached. See "[Opening the System](#)" in "Troubleshooting Your System."
3. Open the hard-drive handle. See [Figure 7-2](#).



Figure 7-2. Installing a SCSI Hard Drive

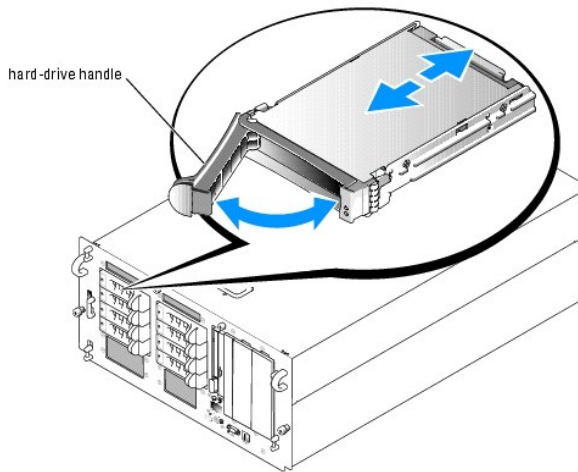

4. Insert the hard drive into the drive bay. See [Figure 7-2](#).
5. Close the hard-drive handle to lock the drive in place.
6. Replace the front bezel, if it was removed in [step 2](#).
7. If the hard drive is a new drive, run the **SCSI Controllers** test in the system diagnostics.

## Removing a SCSI Hard Drive

**NOTICE:** Hot-plug drive removal is not supported for systems without an optional RAID controller card or optional ROMB.

1. If the system does not have an optional RAID controller card or optional ROMB, shut down the system.
2. Remove the front bezel, if attached. See "[Opening the System](#)" in "Troubleshooting Your System."
3. For systems with a RAID controller card or ROMB, power down the hard-drive bay and wait until the SCSI hard-drive indicators on the drive carrier signal that the drive can be removed safely.  
  
If the drive has been online, the green power on/fault indicator will flash as the drive is powered down. When both drive indicators are off, the drive is ready for removal.
4. Open the hard-drive handle to release the drive.
5. Slide the hard drive out until it is free of the drive bay.
6. Replace the front bezel, if it was removed in [step 2](#).

---

## Installing a Diskette Drive

**CAUTION:** Only trained service technicians are authorized to remove the system cover and access any of the components inside the system. See your *Product Information Guide* for complete information about safety precautions, working inside the computer, and protecting against electrostatic discharge.

1. Turn off the system, including any attached peripherals, and disconnect the system from the electrical outlet.
2. Remove the front bezel, if attached. See "[Opening the System](#)" in "Troubleshooting Your System."
3. Open the system. See "[Opening the System](#)" in "Troubleshooting Your System."
4. To remove the drive carrier, pull the release latch forward, then slide the carrier out of the chassis. See [Figure 7-3](#).

Figure 7-3. Installing and Removing the Diskette/Optical Drive Carrier

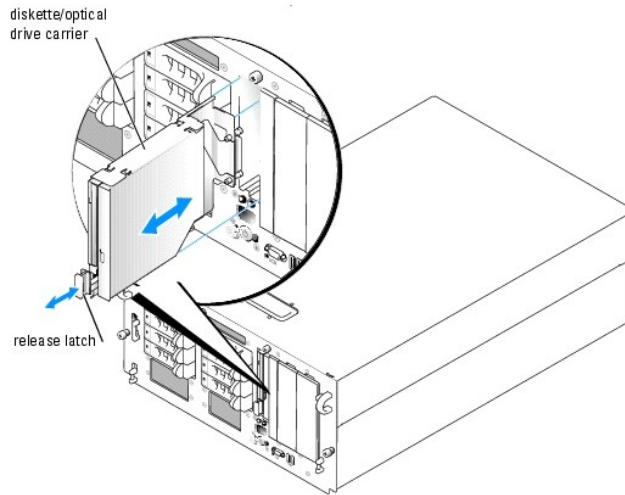

5. Remove the optical drive or optical drive filler plate from the carrier.
  - a. Loosen the thumbscrew on the latch securing the optical drive or filler plate. See [Figure 7-4](#).
  - b. Remove the latch.
  - c. Lift the optical drive or optical drive filler plate from the carrier.

Figure 7-4. Installing a Diskette Drive in the Drive Carrier

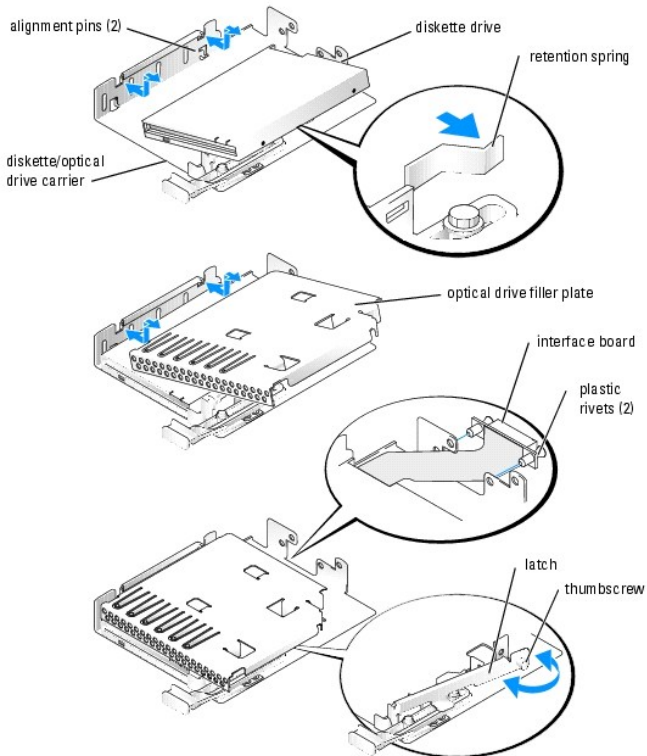

6. To remove the diskette drive filler plate, pull the retention spring slightly away from the filler plate, then lift the filler plate from the carrier.
7. Deflect the retention spring slightly, then insert the diskette drive into the carrier.

The pins on the carrier fit into the corresponding holes in the side of the drive. See [Figure 7-3](#).

8. Replace the optical drive or optical drive filler plate in the carrier.  
The pins on the carrier fit into the corresponding holes in the side of the drive.
  9. Reinstall the latch and tighten the thumbscrew.
  10. Close the system. See "[Closing the System](#)" in "Troubleshooting Your System."
  11. Replace the front bezel, if it was removed in [step 2](#). See "[Closing the System](#)" in "Troubleshooting Your System."
  12. Reconnect the system and peripherals to their electrical outlets.
- 

## Removing the Peripheral Bay Filler Panel (Tower Systems Only)

To facilitate access to optional drives in the peripheral bays, you can remove the peripheral bay filler panel from the system bezel.

1. Remove the front bezel. See "[Opening the System](#)" in "Troubleshooting Your System."
2. From the back of the bezel, press outwards on the four hooks securing the filler panel, then remove the filler panel. See [Figure 7-5](#).

**Figure 7-5. Removing the Peripheral Bay Filler Panel from the Bezel**

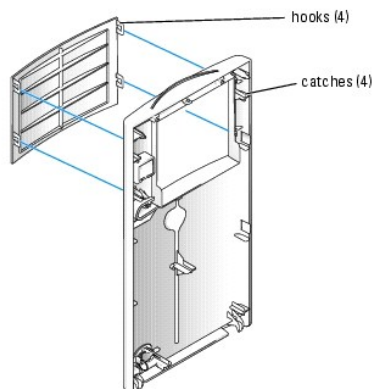

---

## Installing an Optical Drive

**⚠ CAUTION:** Only trained service technicians are authorized to remove the system cover and access any of the components inside the system. See your *Product Information Guide* for complete information about safety precautions, working inside the computer, and protecting against electrostatic discharge.

1. Turn off the system, including any attached peripherals, and disconnect the system from the electrical outlet.
2. Remove the front bezel, if attached. See "[Opening the System](#)" in "Troubleshooting Your System."
3. Open the system. See "[Opening the System](#)" in "Troubleshooting Your System."
4. To remove the drive carrier, pull the release latch forward, then slide the carrier out of the chassis. See [Figure 7-3](#).
5. Remove the optical drive filler plate from the carrier.
  - a. Loosen the thumbscrew from the latch securing the optical drive or filler plate. See [Figure 7-6](#).
  - b. Remove the latch.
  - c. Lift the optical drive filler plate from the carrier.

**Figure 7-6. Installing an Optical Drive in the Drive Carrier**

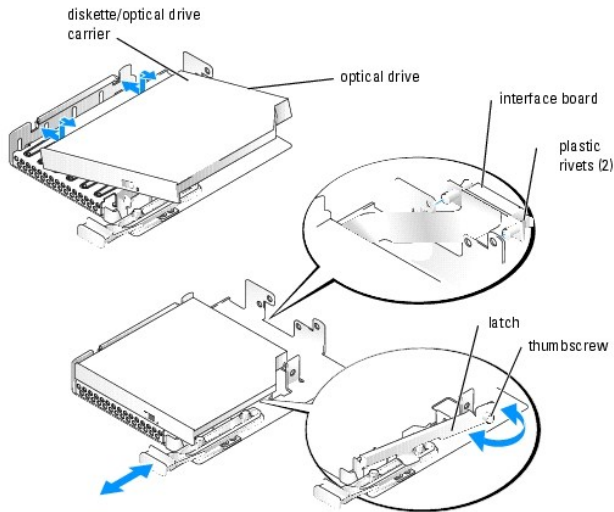

6. Install the new optical drive in the carrier. See [Figure 7-6](#).  
The pins on the carrier fit into the corresponding holes in the side of the drive.
7. Attach the interposer board to the back of the carrier, using the two plastic rivets. See [Figure 7-6](#).
8. Reinstall the latch and tighten the thumbscrew.
9. Close the system. See "[Closing the System](#)" in "Troubleshooting Your System."
10. Replace the front bezel, if it was removed in [step 2](#). See "[Closing the System](#)" in "Troubleshooting Your System."
11. Reconnect the system and peripherals to their electrical outlets.

## Installing an Internal SCSI Tape Drive

This subsection describes how to configure and install an internal SCSI tape drive in the peripheral bays.

**⚠ CAUTION:** Only trained service technicians are authorized to remove the system cover and access any of the components inside the system. See your *Product Information Guide* for complete information about safety precautions, working inside the computer, and protecting against electrostatic discharge.

1. Turn off the system, including any attached peripherals, and disconnect the system from the electrical outlet.
2. Remove the front bezel, if attached. See "[Opening the System](#)" in "Troubleshooting Your System."
3. Open the system. See "[Opening the System](#)" in "Troubleshooting Your System."
4. Ground yourself by touching an unpainted metal surface on the back of the system, unpack the drive, and compare the jumper and switch settings with those in the documentation that came with the drive.
5. Unpack the tape drive (and controller card, if applicable) and configure the tape drive according to the documentation that came with the tape drive, based on the following guidelines:
  - a. Each device attached to a SCSI host adapter must have a unique SCSI ID number. (Narrow SCSI devices use IDs 0 to 7; wide SCSI devices use IDs from 0 to 15). Set the drive's SCSI ID to avoid conflicts with other devices on the SCSI bus. For the default SCSI ID setting, see the documentation provided with the drive.
- 📌 NOTE:** There is no requirement that SCSI ID numbers be assigned sequentially or that devices be attached to the cable in order by ID number.
  - b. SCSI logic requires that the two devices at opposite ends of a SCSI chain be terminated and that all devices in between be unterminated. Therefore, you enable the tape drive's termination if it is the last device in a chain of devices (or sole device) connected to the SCSI controller.
6. If a controller card was included in the drive kit, install the card now. See "[Installing an Expansion Card](#)" in "Installing System Components."

7. Remove the filler plate from the peripheral bay.
  8. If the mounting rails are not attached to the drive, install them now.
  9. Insert the drive into the peripheral bay.
  10. Connect the SCSI interface cable in the drive kit to the drive.
  11. Connect the drive to a SCSI controller:
    1. To use the system's integrated SCSI controller, connect the SCSI interface cable to connector SCSI B on the riser card. See [Figure A-4](#).
    1. If you are connecting the card to an optional SCSI controller card, connect the SCSI interface cable to the SCSI connector on the card.
  12. Connect the power cable supplied with the tape drive to the connector on the drive, and to the power connector on the SCSI backplane. See [Figure A-5](#).
  13. Close the system. See "[Closing the System](#)" in "Troubleshooting Your System."
  14. Replace the front bezel, if it was removed in [step 2](#). See "[Closing the System](#)" in "Troubleshooting Your System."
  15. Reconnect the system and peripherals to their electrical outlets, and turn them on.
  16. If you connected the drive to the integrated SCSI controller on the riser card, enter the System Setup program.

From the **Integrated Devices Screen**, ensure that **Channel B** under the **Embedded RAID Controller** option is set to **SCSI**. See "Using the System Setup Program" in your *User's Guide*.
  17. Perform a tape backup and verification test with the drive as instructed in the software documentation that came with the drive.
- 

## Connecting an External SCSI Tape Drive

This subsection describes how to configure and install an external SCSI tape drive. The drive may be connected to the integrated SCSI controller using the SCSI connector on the system back panel, or to an optional SCSI controller card.

 **CAUTION:** Only trained service technicians are authorized to remove the system cover and access any of the components inside the system. See your *Product Information Guide* for complete information about safety precautions, working inside the computer, and protecting against electrostatic discharge.

1. Turn off the system, including any attached peripherals, and disconnect the system from the electrical outlet.
2. Remove the front bezel, if attached. See "[Opening the System](#)" in "Troubleshooting Your System."
3. Open the system. See "[Opening the System](#)" in "Troubleshooting Your System."
4. Ground yourself by touching an unpainted metal surface on the back of the system, unpack the drive, and compare the jumper and switch settings with those in the documentation that came with the drive.
5. Unpack the tape drive (and controller card, if applicable) and configure the tape drive according to the documentation that came with the tape drive, based on the following guidelines:
  - a. Each device attached to a SCSI host adapter must have a unique SCSI ID number. (Narrow SCSI devices use IDs 0 to 7; wide SCSI devices use IDs from 0 to 15). Set the drive's SCSI ID to avoid conflicts with other devices on the SCSI bus. For the default SCSI ID setting, see the documentation provided with the drive.

 **NOTE:** There is no requirement that SCSI ID numbers be assigned sequentially or that devices be attached to the cable in order by ID number.
  - b. SCSI logic requires that the two devices at opposite ends of a SCSI chain be terminated and that all devices in between be unterminated. Therefore, you enable the tape drive's termination if it is the last device in a chain of devices (or sole device) connected to the SCSI controller.
6. If you are connecting the drive to a controller card, install the controller card in an expansion slot. See "[Installing an Expansion Card](#)" in "Installing System Components."
7. Connect the tape drive's SCSI interface cable to the drive.
8. Connect the other end of the SCSI interface cable to the SCSI controller card, or the external SCSI connector on the system's back panel (see [Figure 2-2](#)).
9. Connect the tape drive's power cable to an electrical outlet.
10. Close the system. See "[Closing the System](#)" in "Troubleshooting Your System."

11. Replace the front bezel, if it was removed in [step 2](#). See "[Closing the System](#)" in "Troubleshooting Your System."
12. Reconnect the system and peripherals to their electrical outlets, and turn them on.
13. Perform a tape backup and verification test with the drive as instructed in the software documentation that came with the drive.

---

## Configuring the Boot Drive

The drive or device from which the system boots is determined by the boot order specified in the System Setup program. See "Using the System Setup Program" in your *User's Guide*.

---

## Activating the Optional Integrated RAID Controller

This subsection explains how to activate your system's integrated RAID controller.

**⚠ CAUTION:** Only trained service technicians are authorized to remove the system cover and access any of the components inside the system. See your *Product Information Guide* for complete information about safety precautions, working inside the computer, and protecting against electrostatic discharge.

**⚠ CAUTION:** Replace the battery only with the same or equivalent type recommended by the manufacturer. Discard used batteries according to the manufacturer's instructions. See your *Product Information Guide* for additional information.

**🔔 NOTICE:** To avoid possible data loss, back up all data on the hard drives before changing the mode of operation of the integrated SCSI controller from SCSI to RAID.

1. Turn off the system, including any attached peripherals, and disconnect the system from the electrical outlet.
2. Remove the cover. See "[Opening the System](#)."
3. Remove the memory cooling shroud by lifting the release latch and sliding the shroud forward. See [Figure 6-16](#).
4. Insert the RAID hardware key into its connector on the system board and secure the key with the latches on each end of the connector. See [Figure 7-7](#) and [Figure A-3](#).

**Figure 7-7. Activating the Integrated RAID Controller**

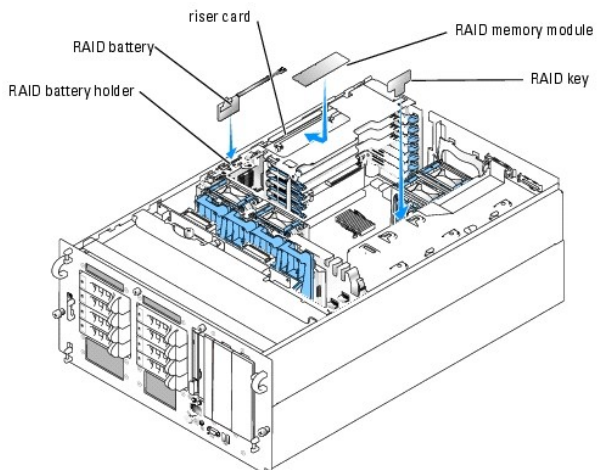

5. Locate the RAID memory module connector on the riser card. See [Figure 7-7](#).
6. Push the ejectors on the RAID memory module connector outward to allow the memory module to be inserted into the connector.
7. Align the RAID memory module's edge connector with the alignment keys, and insert the memory module into the connector.

**🔧 NOTE:** Do not substitute registered memory modules such as those used for system memory. Use the memory module supplied in the RAID upgrade kit.

8. Press on the memory module with your thumbs while closing the ejectors with your index fingers to lock the memory module into the connector.
  9. Insert the RAID battery into the battery holder. See [Figure 7-7](#).
  10. Thread the battery power cable through the hole in the back of the battery holder.
  11. Connect the battery power cable to the RAID battery cable connector on the riser card. See [Figure A-4](#).
  12. Replace the memory cooling shroud.
  13. Replace the cover. See "[Closing the System](#)."
  14. Reconnect the system to its electrical outlet and turn the system on, including any attached peripherals.
  15. Enter the System Setup program and verify that the setting for the SCSI controller has changed to reflect the presence of the RAID hardware. See "Using the System Setup Program" in your *User's Guide*.
  16. Install and configure the RAID software.  
  
See the RAID software documentation for more information.
- 

## Installing a RAID Controller Card

See "[Installing an Expansion Card](#)" in "Installing System Components" for instructions about installing the card. See the RAID controller documentation for information on installing and configuring the RAID software.

---

## SCSI Hard-Drive Cabling Guidelines

### Non-RAID Configurations

For a system without an optional RAID controller installed, connect SCSI channel A on the riser card to connector SC5IA on the SCSI backplane board. If the optional external SCSI cable is installed, connect it to SCSI channel B on the riser card.

### RAID Configurations

If the optional ROMB controller is enabled, or an optional RAID controller card is installed, you can configure the hard drives for RAID operation. The general cabling configurations for various system options are discussed in the following subsections. For details on drive requirements for specific RAID types, see your RAID controller documentation.

#### 1x8 Drive Configuration

For a 1x8 drive configuration with no optional 1x2 backplane installed in the system, connect SCSI channel A on the riser card (see [Figure A-4](#)) or SCSI channel A on the optional RAID card to connector SC5IA on the 1x8 backplane (see [Figure A-5](#)). Drive 0 functions as the boot drive.

#### 1x8 plus 1x2 Drive Configuration

If an optional 1x2 backplane is installed in the peripheral bay, follow these guidelines:

1. Connect the 1x2 backplane to SCSI channel A on the riser card (see [Figure A-4](#)) or SCSI channel A on the optional RAID controller card. Drive 0 in the 1x2 drive cage functions as the boot drive.
1. Connect a SCSI cable from connector SC5IA on the 1x8 backplane (see [Figure A-5](#)) to SCSI channel B on the riser card (see [Figure A-5](#)) or channel B of the optional RAID controller card.

#### 2x4 Split Backplane Configurations

 **NOTICE:** An optional daughter card must be installed on the back of the 1x8 SCSI backplane to support split 2x4 backplane operation.

1. To use the optional integrated ROMB controller in a split 2x4 backplane configuration:
  - o Connect SCSI channel A on the riser card (see [Figure A-4](#)) to connector SC5IA on the SCSI backplane (see [Figure A-5](#)). This channel controls the boot drive (drive 0) and drives 1, 2, and 3.

- o Connect SCSI channel B on the riser card (see [Figure A-4](#)) to connector SCSIB on the SCSI backplane (see [Figure A-5](#)). This channel controls drives 4 through 7.
- 1 To use an optional RAID controller card in a split 2x4 backplane configuration:
- o Connect SCSI channel A (channel 0) on the controller card to connector SCSIA on the SCSI backplane (see [Figure A-5](#)). This channel controls the boot drive (drive 0) and drives 1, 2, and 3.
  - o Connect SCSI channel B (channel 1) on the controller card to connector SCSIB on the SCSI backplane (see [Figure A-5](#)). This channel controls drives 4, 5, 7, and 9.
- 

[Back to Contents Page](#)



[Back to Contents Page](#)

## Getting Help

### Dell™ PowerEdge™ 2800 Systems Installation and Troubleshooting Guide

- [Technical Assistance](#)
  - [Dell Enterprise Training and Certification](#)
  - [Problems With Your Order](#)
  - [Product Information](#)
  - [Returning Items for Warranty Repair or Credit](#)
  - [Before You Call](#)
  - [Contacting Dell](#)
- 

## Technical Assistance

If you need assistance with a technical problem, perform the following steps:

1. Complete the procedures in "[Troubleshooting Your System](#)."
2. Run the system diagnostics and record any information provided.
3. Make a copy of the [Diagnostics Checklist](#), and fill it out.
4. Use Dell's extensive suite of online services available at Dell Support at [support.dell.com](http://support.dell.com) for help with installation and troubleshooting procedures.

For more information, see "[Online Services](#)."

5. If the preceding steps have not resolved the problem, call Dell for technical assistance.

**NOTE:** Call technical support from a phone near or at the system so that technical support can assist you with any necessary procedures.

**NOTE:** Dell's Express Service Code system may not be available in all countries.

When prompted by Dell's automated telephone system, enter your Express Service Code to route the call directly to the proper support personnel. If you do not have an Express Service Code, open the **Dell Accessories** folder, double-click the **Express Service Code** icon, and follow the directions.

For instructions on using the technical support service, see "[Technical Support Service](#)" and "[Before You Call](#)."

**NOTE:** Some of the following services are not always available in all locations outside the continental U.S. Call your local Dell representative for information on availability.

## Online Services

You can access Dell Support at [support.dell.com](http://support.dell.com). Select your region on the **WELCOME TO DELL SUPPORT** page, and fill in the requested details to access help tools and information.

You can contact Dell electronically using the following addresses:

- 1 World Wide Web

[www.dell.com/](http://www.dell.com/)

[www.dell.com/ap/](http://www.dell.com/ap/) (Asian/Pacific countries only)

[www.dell.com/jp](http://www.dell.com/jp/) (Japan only)

[www.euro.dell.com](http://www.euro.dell.com) (Europe only)

[www.dell.com/la](http://www.dell.com/la/) (Latin American countries)

[www.dell.ca](http://www.dell.ca) (Canada only)

- 1 Anonymous file transfer protocol (FTP)

[ftp.dell.com/](ftp://ftp.dell.com/)

Log in as user:anonymous, and use your e-mail address as your password.

- 1 Electronic Support Service

[support@us.dell.com](mailto:support@us.dell.com)

[apsupport@dell.com](mailto:apsupport@dell.com) (Asian/Pacific countries only)

**support.jp.dell.com** (Japan only)

**support.euro.dell.com** (Europe only)

1 Electronic Quote Service

sales@dell.com

apmarketing@dell.com (Asian/Pacific countries only)

sales\_canada@dell.com (Canada only)

1 Electronic Information Service

info@dell.com

## AutoTech Service

Dell's automated technical support service—AutoTech—provides recorded answers to the questions most frequently asked by Dell customers about their portable and desktop computer systems.

When you call AutoTech, use your touch-tone telephone to select the subjects that correspond to your questions.

The AutoTech service is available 24 hours a day, 7 days a week. You can also access this service through the technical support service. See the contact information for your region.

## Automated Order-Status Service

To check on the status of any Dell™ products that you have ordered, you can go to **support.dell.com**, or you can call the automated order-status service. A recording prompts you for the information needed to locate and report on your order. See the contact information for your region.

## Technical Support Service

Dell's technical support service is available 24 hours a day, 7 days a week, to answer your questions about Dell hardware. Our technical support staff use computer-based diagnostics to provide fast, accurate answers.

To contact Dell's technical support service, see "[Before You Call](#)" and then see the contact information for your region.

---

## Dell Enterprise Training and Certification

Dell Enterprise Training and Certification is available; see [www.dell.com/training](http://www.dell.com/training) for more information. This service may not be offered in all locations.

---

## Problems With Your Order

If you have a problem with your order, such as missing parts, wrong parts, or incorrect billing, contact Dell for customer assistance. Have your invoice or packing slip available when you call. See the contact information for your region.

---

## Product Information

If you need information about additional products available from Dell, or if you would like to place an order, visit the Dell website at [www.dell.com](http://www.dell.com). For the telephone number to call to speak to a sales specialist, see the contact information for your region.

---

## Returning Items for Warranty Repair or Credit

Prepare all items being returned, whether for repair or credit, as follows:

1. Call Dell to obtain a Return Material Authorization Number, and write it clearly and prominently on the outside of the box.

For the telephone number to call, see the contact information for your region.

2. Include a copy of the invoice and a letter describing the reason for the return.

3. Include a copy of any diagnostic information (including the Diagnostics Checklist) indicating the tests you have run and any error messages reported by

the system diagnostics.

4. Include any accessories that belong with the item(s) being returned (such as power cables, media such as CDs and diskettes, and guides) if the return is for credit.
5. Pack the equipment to be returned in the original (or equivalent) packing materials.

You are responsible for paying shipping expenses. You are also responsible for insuring any product returned, and you assume the risk of loss during shipment to Dell. Collect-on-delivery (C.O.D.) packages are not accepted.

Returns that are missing any of the preceding requirements will be refused at our receiving dock and returned to you.

---

## Before You Call

**NOTE:** Have your Express Service Code ready when you call. The code helps Dell's automated-support telephone system direct your call more efficiently.

Remember to fill out the [Diagnostics Checklist](#). If possible, turn on your system before you call Dell for technical assistance and call from a telephone at or near the computer. You may be asked to type some commands at the keyboard, relay detailed information during operations, or try other troubleshooting steps possible only at the computer system itself. Ensure that the system documentation is available.

 **CAUTION:** Before servicing any components inside your computer, see your *Product Information Guide* for important safety information.

Diagnostics Checklist
Name:
Date:
Address:
Phone number:
Service Tag (bar code on the back of the computer):
Express Service Code:
Return Material Authorization Number (if provided by Dell support technician):
Operating system and version:
Peripherals:
Expansion cards:
Are you connected to a network? Yes No
Network, version, and network card:
Programs and versions:
See your operating system documentation to determine the contents of the system's start-up files. If possible, print each file. Otherwise, record the contents of each file before calling Dell.
Error message, beep code, or diagnostic code:
Description of problem and troubleshooting procedures you performed:

---

## Contacting Dell

To contact Dell electronically, you can access the following websites:

- 1 [www.dell.com](http://www.dell.com)
- 1 [support.dell.com](http://support.dell.com) (technical support)
- 1 [premiersupport.dell.com](http://premiersupport.dell.com) (technical support for educational, government, healthcare, and medium/large business customers, including Premier, Platinum, and Gold customers)

For specific web addresses for your country, find the appropriate country section in the table below.

**NOTE:** Toll-free numbers are for use within the country for which they are listed.

When you need to contact Dell, use the electronic addresses, telephone numbers, and codes provided in the following table. If you need assistance in determining which codes to use, contact a local or an international operator.

Country (City)	Department Name or Service Area, Website and E-Mail Address	Area Codes, Local Numbers, and Toll-Free Numbers
----------------	--	--

International Access Code Country Code City Code		
<b>Anguilla</b>	General Support	toll-free: 800-335-0031
<b>Antigua and Barbuda</b>	General Support	1-800-805-5924
<b>Argentina (Buenos Aires)</b>	Website: <a href="http://www.dell.com.ar">www.dell.com.ar</a>	
International Access Code: 00	E-mail: <a href="mailto:us_latin_services@dell.com">us_latin_services@dell.com</a>	
Country Code: 54	E-mail for desktop and portable computers: <a href="mailto:la-techsupport@dell.com">la-techsupport@dell.com</a>	
City Code: 11	E-mail for servers and EMC: <a href="mailto:la_enterprise@dell.com">la_enterprise@dell.com</a>	
	Customer Care	toll-free: 0-800-444-0730
	Tech Support	toll-free: 0-800-444-0733
	Tech Support Services	toll-free: 0-800-444-0724
	Sales	0-810-444-3355
<b>Aruba</b>	General Support	toll-free: 800-1578
<b>Australia (Sydney)</b>	E-mail (Australia): <a href="mailto:au_tech_support@dell.com">au_tech_support@dell.com</a>	
International Access Code: 0011	E-mail (New Zealand): <a href="mailto:nz_tech_support@dell.com">nz_tech_support@dell.com</a>	
Country Code: 61	Home and Small Business	1-300-65-55-33
City Code: 2	Government and Business	toll-free: 1-800-633-559
	Preferred Accounts Division (PAD)	toll-free: 1-800-060-889
	For servers and storage	toll-free: 1-800-505-095
	For desktop and portable computers	toll-free: 1-800-733-314
	Customer Care	toll-free: 1-800-819-339
	Corporate Sales	toll-free: 1-800-808-385
	Transaction Sales	toll-free: 1-800-808-312
	Fax	toll-free: 1-800-818-341
<b>Austria (Vienna)</b>	Website: <a href="http://support.euro.dell.com">support.euro.dell.com</a>	
International Access Code: 900	E-mail: <a href="mailto:tech_support_central_europe@dell.com">tech_support_central_europe@dell.com</a>	
Country Code: 43	Home/Small Business Sales	0820 240 530 00
City Code: 1	Home/Small Business Fax	0820 240 530 49
	Home/Small Business Customer Care	0820 240 530 14
	Preferred Accounts/Corporate Customer Care	0820 240 530 16
	Home/Small Business Technical Support	0820 240 530 14
	Preferred Accounts/Corporate Technical Support	0660 8779
	Switchboard	0820 240 530 00
<b>Bahamas</b>	General Support	toll-free: 1-866-278-6818
<b>Barbados</b>	General Support	1-800-534-3066
<b>Belgium (Brussels)</b>	Website: <a href="http://support.euro.dell.com">support.euro.dell.com</a>	
International Access Code: 00	E-mail for French Speaking Customers: <a href="mailto:support.euro.dell.com/be/fr/emaidell/">support.euro.dell.com/be/fr/emaidell/</a>	
Country Code: 32	Technical Support	02 481 92 88
City Code: 2	Technical Support Fax	02 481 92 95
	Customer Care	02 713 15 .65
	Corporate Sales	02 481 91 00
	Fax	02 481 92 99
	Switchboard	02 481 91 00
<b>Bermuda</b>	General Support	1-800-342-0671
<b>Bolivia</b>	General Support	toll-free: 800-10-0238
<b>Brazil</b>	Website: <a href="http://www.dell.com/br">www.dell.com/br</a>	
International Access Code: 00	Customer Support, Technical Support	0800 90 3355
Country Code: 55	Technical Support Fax	51 481 5470
City Code: 51	Customer Care Fax	51 481 5480
	Sales	0800 90 3390
<b>British Virgin Islands</b>	General Support	toll-free: 1-866-278-6820
<b>Brunei</b>	Customer Technical Support (Penang, Malaysia)	604 633 4966
Country Code: 673	Customer Service (Penang, Malaysia)	604 633 4949
	Transaction Sales (Penang, Malaysia)	604 633 4955
<b>Canada (North York, Ontario)</b>	Online Order Status: <a href="http://www.dell.ca/ostatus">www.dell.ca/ostatus</a>	
International Access Code: 011	AutoTech (automated technical support)	toll-free: 1-800-247-9362
	Customer Care (Home Sales/Small Business)	toll-free: 1-800-847-4096

	Customer Care (med./large business, government)	toll-free: 1-800-326-9463
	Technical Support (Home Sales/Small Business)	toll-free: 1-800-847-4096
	Technical Support (med./large bus., government)	toll-free: 1-800-387-5757
	Sales (Home Sales/Small Business)	toll-free: 1-800-387-5752
	Sales (med./large bus., government)	toll-free: 1-800-387-5755
	Spare Parts Sales & Extended Service Sales	1 866 440 3355
<b>Cayman Islands</b>	General Support	1-800-805-7541
<b>Chile (Santiago)</b> Country Code: <b>56</b> City Code: <b>2</b>	Sales, Customer Support, and Technical Support	toll-free: 1230-020-4823
<b>China (Xiamen)</b> Country Code: <b>86</b> City Code: <b>592</b>	Technical Support website: <a href="http://support.dell.com.cn">support.dell.com.cn</a>	
	Technical Support E-mail: <a href="mailto:cn_support@dell.com">cn_support@dell.com</a>	
	Technical Support Fax	818 1350
	Technical Support (Dimension™ and Inspiron™)	toll-free: 800 858 2969
	Technical Support (OptiPlex™, Latitude™, and Dell Precision™)	toll-free: 800 858 0950
	Technical Support (servers and storage)	toll-free: 800 858 0960
	Technical Support (projectors, PDAs, printers, switches, routers, and so on)	toll-free: 800 858 2920
	Customer Advocacy	toll-free: 800 858 2060
	Customer Advocacy Fax	592 818 1308
	Home and Small Business	toll-free: 800 858 2222
	Preferred Accounts Division	toll-free: 800 858 2557
	Large Corporate Accounts GCP	toll-free: 800 858 2055
	Large Corporate Accounts Key Accounts	toll-free: 800 858 2628
	Large Corporate Accounts North	toll-free: 800 858 2999
	Large Corporate Accounts North Government and Education	toll-free: 800 858 2955
	Large Corporate Accounts East	toll-free: 800 858 2020
	Large Corporate Accounts East Government and Education	toll-free: 800 858 2669
	Large Corporate Accounts Queue Team	toll-free: 800 858 2572
	Large Corporate Accounts South	toll-free: 800 858 2355
	Large Corporate Accounts West	toll-free: 800 858 2811
	Large Corporate Accounts Spare Parts	toll-free: 800 858 2621
<b>Colombia</b>	General Support	980-9-15-3978
<b>Costa Rica</b>	General Support	0800-012-0435
<b>Czech Republic (Prague)</b> International Access Code: <b>00</b> Country Code: <b>420</b> City Code: <b>2</b>	Website: <a href="http://support.euro.dell.com">support.euro.dell.com</a>	
	E-mail: <a href="mailto:czech_dell@dell.com">czech_dell@dell.com</a>	
	Technical Support	02 2186 27 27
	Technical Support Fax	02 2186 27 28
	Customer Care	02 2186 27 11
	Customer Care Fax	02 2186 27 14
	Switchboard	02 2186 27 11
<b>Denmark (Copenhagen)</b> International Access Code: <b>00</b> Country Code: <b>45</b>	Website: <a href="http://support.euro.dell.com">support.euro.dell.com</a>	
	E-mail Support (portable computers): <a href="mailto:den_nbk_support@dell.com">den_nbk_support@dell.com</a>	
	E-mail Support (desktop computers): <a href="mailto:den_support@dell.com">den_support@dell.com</a>	
	E-mail Support (servers): <a href="mailto:Nordic_server_support@dell.com">Nordic_server_support@dell.com</a>	
	Technical Support	7023 0182
	Customer Care (Relational)	7023 0184
	Home/Small Business Customer Care	3287 5505
	Switchboard (Relational)	3287 1200
	Switchboard Fax (Relational)	3287 1201
	Switchboard (Home/Small Business)	3287 5000
	Switchboard Fax (Home/Small Business)	3287 5001
<b>Dominica</b>	General Support	toll-free: 1-866-278-6821
<b>Dominican Republic</b>	General Support	1-800-148-0530
<b>Ecuador</b>	General Support	toll-free: 999-119
<b>El Salvador</b>	General Support	01-899-753-0777
<b>Finland (Helsinki)</b> International Access Code: <b>990</b>	Website: <a href="http://support.euro.dell.com">support.euro.dell.com</a>	
	E-mail: <a href="mailto:fin_support@dell.com">fin_support@dell.com</a>	

Country Code: <b>358</b> City Code: <b>9</b>	E-mail Support (servers): Nordic_support@dell.com	
	Technical Support	09 253 313 60
	Technical Support Fax	09 253 313 81
	Relational Customer Care	09 253 313 38
	Home/Small Business Customer Care	09 693 791 94
	Fax	09 253 313 99
	Switchboard	09 253 313 00
<b>France (Paris) (Montpellier)</b>	Website: <b>support.euro.dell.com</b>	
International Access Code: <b>00</b>	E-mail: <b>support.euro.dell.com/fr/fr/emaildell/</b>	
	<b>Home and Small Business</b>	
Country Code: <b>33</b>	Technical Support	0825 387 270
City Codes: <b>(1) (4)</b>	Customer Care	0825 823 833
	Switchboard	0825 004 700
	Switchboard (calls from outside of France)	04 99 75 40 00
	Sales	0825 004 700
	Fax	0825 004 701
	Fax (calls from outside of France)	04 99 75 40 01
	<b>Corporate</b>	
	Technical Support	0825 004 719
	Customer Care	0825 338 339
	Switchboard	01 55 94 71 00
Sales	01 55 94 71 00	
Fax	01 55 94 71 01	
<b>Germany (Langen)</b>	Website: <b>support.euro.dell.com</b>	
International Access Code: <b>00</b>	E-mail: tech_support_central_europe@dell.com	
	Technical Support	06103 766-7200
Country Code: <b>49</b>	Home/Small Business Customer Care	0180-5-224400
City Code: <b>6103</b>	Global Segment Customer Care	06103 766-9570
	Preferred Accounts Customer Care	06103 766-9420
	Large Accounts Customer Care	06103 766-9560
	Public Accounts Customer Care	06103 766-9555
	Switchboard	06103 766-7000
<b>Greece</b>	Website: <b>support.euro.dell.com</b>	
International Access Code: <b>00</b>	E-mail: <b>support.euro.dell.com/gr/en/emaildell/</b>	
	Technical Support	00800-44 14 95 18
Country Code: <b>30</b>	Gold Service Technical Support	00800-44 14 00 83
	Switchboard	2108129810
	Gold Service Switchboard	2108129811
	Sales	2108129800
	Fax	2108129812
<b>Grenada</b>	General Support	toll-free: 1-866-540-3355
<b>Guatemala</b>	General Support	1-800-999-0136
<b>Guyana</b>	General Support	toll-free: 1-877-270-4609
<b>Hong Kong</b>	Website: <b>support.ap.dell.com</b>	
International Access Code: <b>001</b>	E-mail: <b>apsupport@dell.com</b>	
	Technical Support (Dimension™ and Inspiron™)	2969 3188
Country Code: <b>852</b>	Technical Support (OptiPlex™, Latitude™, and Dell Precision™)	2969 3191
	Technical Support (PowerApp™, PowerEdge™, PowerConnect™, and PowerVault™)	2969 3196
	Gold Queue EEC Hotline	2969 3187
	Customer Advocacy	3416 0910
	Large Corporate Accounts	3416 0907
	Global Customer Programs	3416 0908
	Medium Business Division	3416 0912
	Home and Small Business Division	2969 3155
<b>India</b>	Technical Support	1600 33 8045
	Sales	1600 33 8044
<b>Ireland (Cherrywood)</b>	Website: <b>support.euro.dell.com</b>	
International Access Code: <b>16</b>	E-mail: <b>dell_direct_support@dell.com</b>	

Country Code: <b>353</b> City Code: <b>1</b>	Technical Support	1850 543 543
	U.K. Technical Support (dial within U.K. only)	0870 908 0800
	Home User Customer Care	01 204 4014
	Small Business Customer Care	01 204 4014
	U.K. Customer Care (dial within U.K. only)	0870 906 0010
	Corporate Customer Care	1850 200 982
	Corporate Customer Care (dial within U.K. only)	0870 907 4499
	Ireland Sales	01 204 4444
	U.K. Sales (dial within U.K. only)	0870 907 4000
	Fax/Sales Fax	01 204 0103
Switchboard	01 204 4444	
<b>Italy (Milan)</b>	Website: <a href="http://support.euro.dell.com">support.euro.dell.com</a>	
International Access Code: <b>00</b>	E-mail: <a href="mailto:support.euro.dell.com/it/it/emaildell/">support.euro.dell.com/it/it/emaildell/</a>	
Country Code: <b>39</b> City Code: <b>02</b>	<b>Home and Small Business</b>	
	Technical Support	02 577 826 90
	Customer Care	02 696 821 14
	Fax	02 696 821 13
	Switchboard	02 696 821 12
	<b>Corporate</b>	
	Technical Support	02 577 826 90
	Customer Care	02 577 825 55
	Fax	02 575 035 30
	Switchboard	02 577 821
<b>Jamaica</b>	General Support (dial from within Jamaica only)	1-800-682-3639
<b>Japan (Kawasaki)</b>	Website: <a href="http://support.jp.dell.com">support.jp.dell.com</a>	
International Access Code: <b>001</b>	Technical Support (servers)	toll-free: 0120-198-498
Country Code: <b>81</b> City Code: <b>44</b>	Technical Support outside of Japan (servers)	81-44-556-4162
	Technical Support (Dimension™ and Inspiron™)	toll-free: 0120-198-226
	Technical Support outside of Japan (Dimension and Inspiron)	81-44-520-1435
	Technical Support (Dell Precision™, OptiPlex™, and Latitude™)	toll-free: 0120-198-433
	Technical Support outside of Japan (Dell Precision, OptiPlex, and Latitude)	81-44-556-3894
	Technical Support (PDAs, projectors, printers, routers)	toll-free: 0120-981-690
	Technical Support outside of Japan (PDAs, projectors, printers, routers)	81-44-556-3468
	Faxbox Service	044-556-3490
	24-Hour Automated Order Service	044-556-3801
	Customer Care	044-556-4240
Business Sales Division (up to 400 employees)	044-556-1465	
Preferred Accounts Division Sales (over 400 employees)	044-556-3433	
Large Corporate Accounts Sales (over 3500 employees)	044-556-3430	
Public Sales (government agencies, educational institutions, and medical institutions)	044-556-1469	
Global Segment Japan	044-556-3469	
Individual User	044-556-1760	
Switchboard	044-556-4300	
<b>Korea (Seoul)</b>	Technical Support	toll-free: 080-200-3800
International Access Code: <b>001</b>	Sales	toll-free: 080-200-3600
Country Code: <b>82</b> City Code: <b>2</b>	Customer Service (Seoul, Korea)	toll-free: 080-200-3800
	Customer Service (Penang, Malaysia)	604 633 4949
	Fax	2194-6202
	Switchboard	2194-6000
<b>Latin America</b>	Customer Technical Support (Austin, Texas, U.S.A.)	512 728-4093
	Customer Service (Austin, Texas, U.S.A.)	512 728-3619
	Fax (Technical Support and Customer Service) (Austin, Texas, U.S.A.)	512 728-3883
	Sales (Austin, Texas, U.S.A.)	512 728-4397
	SalesFax (Austin, Texas, U.S.A.)	512 728-4600
		or 512 728-3772
<b>Luxembourg</b>	Website: <a href="http://support.euro.dell.com">support.euro.dell.com</a>	
International Access Code: <b>00</b>	E-mail: <a href="mailto:tech_be@dell.com">tech_be@dell.com</a>	
	Technical Support (Brussels, Belgium)	3420808075

Country Code: <b>352</b>	Home/Small Business Sales (Brussels, Belgium)	toll-free: 080016884
	Corporate Sales (Brussels, Belgium)	02 481 91 00
	Customer Care (Brussels, Belgium)	02 481 91 19
	Fax (Brussels, Belgium)	02 481 92 99
	Switchboard (Brussels, Belgium)	02 481 91 00
<b>Macao</b>	Technical Support	toll-free: 0800 582
Country Code: <b>853</b>	Customer Service (Penang, Malaysia)	604 633 4949
	Transaction Sales	toll-free: 0800 581
<b>Malaysia (Penang)</b>	Technical Support (Dell Precision, OptiPlex, and Latitude)	toll-free: 1 800 88 0193
International Access Code: <b>00</b>	Technical Support (Dimension and Inspiron)	toll-free: 1 800 88 1306
	Technical Support (PowerEdge and PowerVault)	toll-free: 1800 88 1386
Country Code: <b>60</b>	Customer Service	04 633 4949
	Transaction Sales	toll-free: 1 800 888 202
City Code: <b>4</b>	Corporate Sales	toll-free: 1 800 888 213
<b>Mexico</b>	Customer Technical Support	001-877-384-8979 or 001-877-269-3383
International Access Code: <b>00</b>		
Country Code: <b>52</b>	Sales	50-81-8800 or 01-800-888-3355
	Customer Service	001-877-384-8979 or 001-877-269-3383
	Main	50-81-8800 or 01-800-888-3355
<b>Montserrat</b>	General Support	toll-free: 1-866-278-6822
<b>Netherlands Antilles</b>	General Support	001-800-882-1519
<b>Netherlands (Amsterdam)</b>	Website: <a href="http://support.euro.dell.com">support.euro.dell.com</a>	
International Access Code: <b>00</b>	Technical Support	020 674 45 00
	Technical Support Fax	020 674 47 66
	Home/Small Business Customer Care	020 674 42 00
	Relational Customer Care	020 674 4325
	Home/Small Business Sales	020 674 55 00
	Relational Sales	020 674 50 00
	Home/Small Business Sales Fax	020 674 47 75
	Relational Sales Fax	020 674 47 50
	Switchboard	020 674 50 00
	Switchboard Fax	020 674 47 50
<b>New Zealand</b>	E-mail (New Zealand): <a href="mailto:nz_tech_support@dell.com">nz_tech_support@dell.com</a>	
	E-mail (Australia): <a href="mailto:au_tech_support@dell.com">au_tech_support@dell.com</a>	
	Technical Support (for desktop and portable computers)	0800 443 563
	Technical Support (for servers and storage)	0800 505 098
	Home and Small Business	0800 446 255
	Government and Business	0800 444 617
	Sales	0800 441 567
	Fax	0800 441 566
<b>Nicaragua</b>	General Support	001-800-220-1006
<b>Norway (Lysaker)</b>	Website: <a href="http://support.euro.dell.com">support.euro.dell.com</a>	
International Access Code: <b>00</b>	E-mail Support (portable computers): <a href="mailto:nor_nbk_support@dell.com">nor_nbk_support@dell.com</a>	
	E-mail Support (desktop computers): <a href="mailto:nor_support@dell.com">nor_support@dell.com</a>	
Country Code: <b>47</b>	E-mail Support (servers): <a href="mailto:nordic_server_support@dell.com">nordic_server_support@dell.com</a>	
	Technical Support	671 16882
	Relational Customer Care	671 17514
	Home/Small Business Customer Care	23162298
	Switchboard	671 16800
	Fax Switchboard	671 16865



<b>Panama</b>	General Support	001-800-507-0962
<b>Peru</b>	General Support	0800-50-669
<b>Poland (Warsaw)</b>	Website: <a href="http://support.euro.dell.com">support.euro.dell.com</a>	
International Access Code: <b>011</b>	E-mail: <a href="mailto:pl_support_tech@dell.com">pl_support_tech@dell.com</a>	
Country Code: <b>48</b>	Customer Service Phone	57 95 700
City Code: <b>22</b>	Customer Care	57 95 999
	Sales	57 95 999
	Customer Service Fax	57 95 806
	Reception Desk Fax	57 95 998
	Switchboard	57 95 999
<b>Portugal</b>	Website: <a href="http://support.euro.dell.com">support.euro.dell.com</a>	
International Access Code: <b>00</b>	E-mail: <a href="mailto:support.euro.dell.com/pt/en/emaiddell/">support.euro.dell.com/pt/en/emaiddell/</a>	
Country Code: <b>351</b>	Technical Support	707200149
	Customer Care	800 300 413
	Sales	800 300 410 or 800 300 411 or 800 300 412 or 21 422 07 10
	Fax	21 424 01 12
<b>Puerto Rico</b>	General Support	1-800-805-7545
<b>St. Kitts and Nevis</b>	General Support	toll-free: 1-877-441-4731
<b>St. Lucia</b>	General Support	1-800-882-1521
<b>St. Vincent and the Grenadines</b>	General Support	toll-free: 1-877-270-4609
<b>Singapore (Singapore)</b>	Technical Support (Dimension and Inspiron)	toll-free: 1800 394 7430
International Access Code: <b>005</b>	Technical Support (Optiplex, Latitude, and Precision)	toll-free: 1800 394 7488
Country Code: <b>65</b>	Technical Support (PowerEdge and PowerVault)	toll-free: 1800 394 7478
	Customer Service (Penang, Malaysia)	604 633 4949
	Transaction Sales	toll-free: 800 6011 054
	Corporate Sales	toll-free: 800 6011 053
<b>South Africa (Johannesburg)</b>	Website: <a href="http://support.euro.dell.com">support.euro.dell.com</a>	
International Access Code: <b>09/091</b>	E-mail: <a href="mailto:dell_za_support@dell.com">dell_za_support@dell.com</a>	
Country Code: <b>27</b>	Gold Queue	011 709 7713
City Code: <b>11</b>	Technical Support	011 709 7710
	Customer Care	011 709 7707
	Sales	011 709 7700
	Fax	011 706 0495
	Switchboard	011 709 7700
<b>Southeast Asian and Pacific Countries</b>	Customer Technical Support, Customer Service, and Sales (Penang, Malaysia)	604 633 4810
<b>Spain (Madrid)</b>	Website: <a href="http://support.euro.dell.com">support.euro.dell.com</a>	
International Access Code: <b>00</b>	E-mail: <a href="mailto:support.euro.dell.com/es/es/emaiddell/">support.euro.dell.com/es/es/emaiddell/</a>	
Country Code: <b>34</b>	<b>Home and Small Business</b>	
City Code: <b>91</b>	Technical Support	902 100 130
	Customer Care	902 118 540
	Sales	902 118 541
	Switchboard	902 118 541
	Fax	902 118 539
	<b>Corporate</b>	
	Technical Support	902 100 130
	Customer Care	902 115 236
	Switchboard	91 722 92 00
	Fax	91 722 95 83
<b>Sweden (Upplands Vasby)</b>	Website: <a href="http://support.euro.dell.com">support.euro.dell.com</a>	
International Access Code: <b>00</b>	E-mail: <a href="mailto:swe_support@dell.com">swe_support@dell.com</a>	
Country Code: <b>46</b>	E-mail Support for Latitude and Inspiron: <a href="mailto:Swe-nbk_kats@dell.com">Swe-nbk_kats@dell.com</a>	
City Code: <b>8</b>	E-mail Support for OptiPlex: <a href="mailto:Swe_kats@dell.com">Swe_kats@dell.com</a>	
	E-mail Support for Servers: <a href="mailto:Nordic_server_support@dell.com">Nordic_server_support@dell.com</a>	
	Technical Support	08 590 05 199
	Relational Customer Care	08 590 05 642
	Home/Small Business Customer Care	08 587 70 527
	Employee Purchase Program (EPP) Support	20 140 14 44

	Technical Support Fax	08 590 05 594
	Sales	08 590 05 185
<b>Switzerland (Geneva)</b>	Website: <a href="http://support.euro.dell.com">support.euro.dell.com</a>	
International Access Code: <b>00</b>	E-mail: Tech_support_central_Europe@dell.com	
Country Code: <b>41</b>	E-mail for French-speaking HSB and Corporate Customers: <a href="mailto:support.euro.dell.com/ch/fr/emaildell/">support.euro.dell.com/ch/fr/emaildell/</a>	
City Code: <b>22</b>	Technical Support (Home and Small Business)	0844 811 411
	Technical Support (Corporate)	0844 822 844
	Customer Care (Home and Small Business)	0848 802 202
	Customer Care (Corporate)	0848 821 721
	Fax	022 799 01 90
	Switchboard	022 799 01 01
<b>Taiwan</b>	Technical Support (portable and desktop computers)	toll-free: 00801 86 1011
International Access Code: <b>002</b>	Technical Support (servers and storage)	toll-free: 00801 60 1256
Country Code: <b>886</b>	Corporate Sales	toll-free: 00801 651 227
<b>Thailand</b>	Technical Support (Optiplex, Latitude, and Precision)	toll-free: 1800 0060 07
International Access Code: <b>001</b>	Technical Support (PowerEdge and PowerVault)	toll-free: 1800 0600 09
Country Code: <b>66</b>	Customer Service (Penang, Malaysia)	604 633 4949
	Sales	toll-free: 0880 060 09
<b>Trinidad/Tobago</b>	General Support	1-800-805-8035
<b>Turks and Caicos Islands</b>	General Support	toll-free: 1-866-540-3355
<b>U.K. (Bracknell)</b>	Website: <a href="http://support.euro.dell.com">support.euro.dell.com</a>	
International Access Code: <b>00</b>	Customer Care website: <a href="http://support.euro.dell.com/uk/en/ECare/Form/Home.asp">support.euro.dell.com/uk/en/ECare/Form/Home.asp</a>	
Country Code: <b>44</b>		
City Code: <b>1344</b>	E-mail: <a href="mailto:dell_direct_support@dell.com">dell_direct_support@dell.com</a>	
	Technical Support (Corporate/Preferred Accounts/PAD [1000+ employees])	0870 908 0500
	Technical Support (direct/PAD and general)	0870 908 0800
	Global Accounts Customer Care	01344 373 186
	Home and Small Business Customer Care	0870 906 0010
	Corporate Customer Care	01344 373 185
	Preferred Accounts (500-5000 employees) Customer Care	0870 906 0010
	Central Government Customer Care	01344 373 193
	Local Government & Education Customer Care	01344 373 199
	Health Customer Care	01344 373 194
	Home and Small Business Sales	0870 907 4000
	Corporate/Public Sector Sales	01344 860 456
	Home and Small Business Fax	0870 907 4006
<b>Uruguay</b>	General Support	toll-free: 000-413-598-2521
<b>U.S.A. (Austin, Texas)</b>	Automated Order-Status Service	toll-free: 1-800-433-9014
International Access Code: <b>011</b>	AutoTech (portable and desktop computers)	toll-free: 1-800-247-9362
Country Code: <b>1</b>	<b>Consumer (Home and Home Office)</b>	
	Technical Support	toll-free: 1-800-624-9896
	Customer Service	toll-free: 1-800-624-9897
	<b>DellNet™ Service and Support</b>	toll-free: 1-877-Dellnet (1-877-335-5638)
	Employee Purchase Program (EPP) Customers	toll-free: 1-800-695-8133
	Financial Services website: <a href="http://www.dellfinancialservices.com">www.dellfinancialservices.com</a>	
	Financial Services (lease/loans)	toll-free: 1-877-577-3355
	Financial Services (Dell Preferred Accounts [DPA])	toll-free: 1-800-283-2210
	<b>Business</b>	
	Customer Service and Technical Support	toll-free: 1-800-822-8965
	Employee Purchase Program (EPP) Customers	toll-free: 1-800-695-8133
	Printers and Projectors Technical Support	toll-free: 1-877-459-7298
	<b>Public (government, education, and healthcare)</b>	
	Customer Service and Technical Support	toll-free: 1-800-456-3355
	Employee Purchase Program (EPP) Customers	toll-free: 1-800-234-1490
	Dell Sales	toll-free: 1-800-289-3355

		or toll-free: 1-800-879-3355
	Dell Outlet Store (Dell refurbished computers)	toll-free: 1-888-798-7561
	Software and Peripherals Sales	toll-free: 1-800-671-3355
	Spare Parts Sales	toll-free: 1-800-357-3355
	Extended Service and Warranty Sales	toll-free: 1-800-247-4618
	Fax	toll-free: 1-800-727-8320
	Dell Services for the Deaf, Hard-of-Hearing, or Speech-Impaired	toll-free: 1-877-DELLTTY (1-877-335-5889)
<b>U.S. Virgin Islands</b>	General Support	1-877-673-3355
<b>Venezuela</b>	General Support	8001-3605



[Back to Contents Page](#)

[Back to Contents Page](#)

## Dell™ PowerEdge™ 2800 Systems Installation and Troubleshooting Guide

---

### Notes, Notices, and Cautions

-  **NOTE:** A NOTE indicates important information that helps you make better use of your computer.
  -  **NOTICE:** A NOTICE indicates either potential damage to hardware or loss of data and tells you how to avoid the problem.
  -  **CAUTION:** A CAUTION indicates a potential for property damage, personal injury, or death.
- 

### Abbreviations and Acronyms

For a complete list of abbreviations and acronyms, see the Glossary in your *User's Guide*.

---

---

---

---

Information in this document is subject to change without notice.  
© 2004 Dell Inc. All rights reserved.

Reproduction in any manner whatsoever without the written permission of Dell Inc. is strictly forbidden.

Trademarks used in this text: *Dell*, the *DELL* logo, *PowerEdge*, *PowerVault*, *Dell OpenManage*, *Dimension*, *Inspiron*, *OptiPlex*, *Latitude*, *Dell Precision*, *PowerApp*, *PowerConnect*, *Axim*, and *DellNet* are trademarks of Dell Inc.

Other trademarks and trade names may be used in this document to refer to either the entities claiming the marks and names or their products. Dell Inc. disclaims any proprietary interest in trademarks and trade names other than its own.

August 2004 P/N P1778 Rev. A00

---

[Back to Contents Page](#)